

2023

Büyük işler
sorumluluk ister
Business need reliability



ürün katalođu
product catalogue



hakkımızda

İlk olarak 1982 yılında üretim ve pazarlama sektörüne güneş enerjisi ,termosifon ve boyler imalatları ile adım atan Teksan, pazardaki ihtiyaç ve müşteri talepleri doğrultusunda mekanik seperatör üretimine başlamıştır. Mekanik seperatörler denge kabı, tortu tutucu, hava ayırıcı, akümülyasyon tankları,nötralizasyon ünitesi olarak yurtiçi ve yurtdışında satışa sunulmaktadır. Ayrıca Teksan Satış & Pazarlama bölümü olarak birçok büyük firmanında dağıtıcı bayiliğini üstlenerek müşterilerimize güçlü bir çözüm ortağı olmayı hedeflemiştir. Bugün Teksan olarak 2500 m²si kapalı olmak üzere toplam 7500 m² lik tesisimizde sürekli geliştirdiğimiz makine parkurumuz ve ürün çeşitlerimizle yurtiçi ve yurtdışı pazarda her zaman güvenilir, daha kaliteli ,dinamik ve gün geçtikçe büyüyen bir aile olarak yolunda emin adımlarla devam etmektedir.

“Büyük işler büyük sorumluluk ister”

about us

Our company has started producing and marketing Solar Water Heater, geyser and boiler since 1982.By the time Teksan started to produce mechanical separators on customer demands. Mechanical separators are Hydraulic separator, dirt separator, air separator, combined separator, (Hydraulic dirt & air separator, and innovative new Hydraulic dirt & air + magnetic separator) and the neutralization tank which are selling at domestic market and also exporting more than 10 different countries. Teksan’s SALE & MARKETING department is also the distributor of many big companies (shown at the end of the cat.) of Turkey. We are trying to give you the best and reliable products and service with our 7500 m² factory which process by high tech machinery equipment.

“Business need reliability”

içindekiler

contents

sayfa / page
23

sertifikalar
certificates

sayfa / page

21
22

düz flanş & kep
flat flange P16 & cap

sayfa / page

20

kaskad bağlantı sistemleri
kaskad connection systems

sayfa / page

18
19

tanklar
tanks

sayfa / page

16

boyler
boilers

sayfa / page

13
14

nötralizasyon tankları
neutralization tanks

sayfa / page

05
11

seperatörler
separators



Seperatörler separators



01

Avrupa standartlarında üretim

Production in European norms

02

hızlı teslimat güvenilir ürün

Fast shipping reliable product

03

statik boya

Static dyeing

04

ISO 14001 belgesiyle Türkiye'de tek çevre dostu

Environmentally friendly with ISO14001 quality certificate



Büyük işler sorumluluk ister
Business need reliability



www.teksanisi.com



TEKSAN[®]
ISI & DOĞALGAZ MÜHENDİSLİK



DENGİ KABI
HYDRAULIC SEPARATOR

BİRLEŞİK KAP
COMBINED SEPARATOR

TORTU TUTUCU
DIRT SEPARATOR

HAVA AYIRICI
AIR SEPARATOR

TORTU HAVA AYIRICI
DIRT & AIR SEPARATOR

TORTU TUTUCU & MANYETİK FİLTRE
DIRT SEPARATOR & MAGNETIC FILTER

BİRLEŞİK KAP & MANYETİK FİLTRE
COMBINED SEPARATOR & MAGNETIC FILTER

Seperatörler separators



www.teksanisi.com

DENGE KABI

HYDRAULIC SEPARATOR



TR

Merkezi sistemlerde ısı verimini arttırmak amacı ile kullanılır. Çoğu teknik şartnameler kaskad sistemlerde denge kabı kullanılmasını zorunlu kılmıştır.

Bunun sebebi kaskad sistemlerde kullanılan kazan veya kombi pompası ile tesisattaki sirkülasyon pompaları oluşan debi ve basınç farkını ortadan kaldırmaktır.

EN

Our hydraulic separators are designed to offer optimal efficiency of central heating systems. Technical specifications required the hydraulic separators at central heating systems now our hydraulic separators offer the best pressure optimization systemically.



MADE IN TURKEY

teknik detaylar
technical details

KOD	GÜÇ	GİRİŞ-ÇIKIŞ (İNÇ)	GİRİŞ-ÇIKIŞ(DN)	M3	GALON	D(mm)	H(cm)	A(mm)	a(mm)	d(mm)	B(mm)	KAYNAKLI	FLANŞLI
TDK001	40KW	1"	DN25	1,72	454	76	35	173	159	33,7	203	₺ 1.350,00	
TDK002	50KW	1 1/4"	DN32	2,15	567	89	34	189	159	46	214	₺ 1.462,50	
TDK003	70KW	1 1/2"	DN40	3,01	794	89	39	239	209	48,3	251,7	₺ 1.525,00	₺ 2.550,00
TDK004	115KW	2"	DN50	4,95	1306	114	53	264	234	60,3	319,7	₺ 2.050,00	₺ 3.375,00
TDK005	135KW	2 1/2"	DN65	5,8	1531	141	60,4	311	281	76,1	353,9	₺ 2.412,50	₺ 3.787,50
TDK006	185KW	2 1/2"	DN65	7,95	2099	169	71	359	329	76,1	403,9	₺ 3.025,00	₺ 4.412,50
TDK007	235KW	3"	DN80	10,1	2667	169	77	359	329	88,9	451,1	₺ 3.775,00	₺ 5.375,00
TDK008	310KW	3"	DN80	13,33	3519	219	78	409	379	88,9	451,1	₺ 5.050,00	₺ 6.675,00
TDK009	360KW	4"	DN100	15,48	4087	219	88	409	379	114,3	495,7	₺ 5.575,00	₺ 7.562,50
TDK010	510KW	4"	DN100	21,93	5790	273	90	463	433	114,3	455,6	₺ 6.875,00	₺ 8.900,00
TDK011	635kw	5"	DN125	27,3	7207	273	116	463	433	139,7	730,2	₺ 8.125,00	₺ 10.562,50
TDK012	760KW	5"	DN125	32,68	2652	273	138	463	433	139,7	910,3	₺ 9.025,00	₺ 11.525,00
TDK013	900KW	6"	DN150	38,7	10217	323	143,4	513	483	168,3	911,7	₺ 12.150,00	₺ 15.375,00
TDK014	1150kw	6"	DN150	49,45	13055	355	179	585	555	168,3	1212,7	₺ 15.700,00	₺ 20.250,00
TDK015	1600KW	8"	DN200	68,8	18163	406	208	672	628	219,1	1371,9	₺ 19.125,00	₺ 25.500,00
TDK016	2000kw	8"	DN200	86	22704	457	243	749	697	219,1	1660,9	₺ 21.625,00	₺ 28.750,00
TDK017	2300KW	8"	DN200	89,9	23734	508	250	840	788	219,1	1670,9	₺ 24.875,00	₺ 33.500,00
TDK018	2650KW	10"	DN250	113,95	30083	559	265	915,5	863,5	273	1687	₺ 36.000,00	₺ 47.875,00
TDK019	3550KW	10"	DN250	152,65	40300	610	321	948	890	273	2137	₺ 42.250,00	₺ 56.250,00
TDK020	5100KW	12"	DN300	219,3	57895	800	356	1144	1080	323	2397,2	₺ 53.000,00	₺ 80.000,00

* ÜRÜNLERİMİZ - + %5 DEĞİŞKENLİK GÖSTEREBİLİR.





BİRLEŞİK KAP

COMBINED SEPARATOR



TR

Teksan birleşik kaplar ısıtma veya soğutma tesisatlarında hidrolik dengenin yanı sıra tortu ve hava ayırma görevinde üstlenir. Yani birleşik kap ; Denge kabı ,tortu tutucu ve hava ayırıcı kapların görevini tek başına üstlenir

EN

Our hydraulic separators are designed to offer optimal efficiency of central heating systems. Technical specifications required the hydraulic separators at central heating systems now our hydraulic separators offer the best pressure optimization systemically.



MADE IN TURKEY

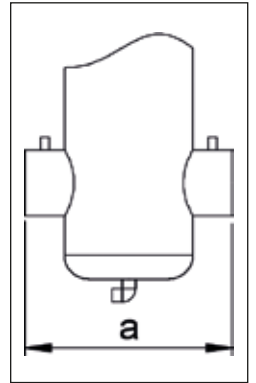
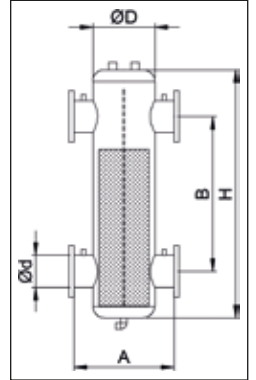

teknik detaylar
technical details

KOD	GÜÇ	GİRİŞ-ÇIKIŞ (İNÇ)	GİRİŞ-ÇIKIŞ(DN)	M3	GALON	D(mm)	H(cm)	A(mm)	a(mm)	d(mm)	B(mm)	Kaynaklı	Flanşlı
TBK001	40KW	1"	DN25	1,72	454	76	35	173	159	33,7	203	± 2.325,00	
TBK002	50KW	1 1/4"	DN32	2,15	567	89	34	189	159	46	214	± 2.475,00	
TBK003	70KW	1 1/2"	DN40	3,01	794	89	39	239	209	48,3	251,7	± 2.600,00	± 4.450,00
TBK004	115KW	2"	DN50	4,95	1306	114	53	264	234	60,3	319,7	± 3.425,00	± 5.875,00
TBK005	135KW	2 1/2"	DN65	5,8	1531	141	60,4	311	281	76,1	353,9	± 4.450,00	± 7.250,00
TBK006	185KW	2 1/2"	DN65	7,95	2099	169	71	359	329	76,1	403,9	± 5.550,00	± 8.375,00
TBK007	235KW	3"	DN80	10,1	2667	169	77	359	329	88,9	451,1	± 6.925,00	± 10.225,00
TBK008	310KW	3"	DN80	13,33	3519	219	78	409	379	88,9	451,1	± 8.475,00	± 11.625,00
TBK009	360KW	4"	DN100	15,48	4087	219	88	409	379	114,3	495,7	± 8.500,00	± 12.025,00
TBK010	510KW	4"	DN100	21,93	5790	273	90	463	433	114,3	455,6	± 9.950,00	± 13.125,00
TBK011	635kw	5"	DN125	27,3	7207	273	116	463	433	139,7	730,2	± 11.375,00	± 15.300,00
TBK012	760KW	5"	DN125	32,68	2652	273	138	463	433	139,7	910,3	± 12.600,00	± 16.700,00
TBK013	900KW	6"	DN150	38,7	10217	323	143,4	513	483	168,3	911,7	± 17.000,00	± 22.250,00
TBK014	1150kw	6"	DN150	49,45	13055	355	179	585	555	168,3	1212,7	± 20.875,00	± 27.250,00
TBK015	1600KW	8"	DN200	68,8	18163	406	208	672	628	219,1	1371,9	± 27.000,00	± 37.375,00
TBK016	2000kw	8"	DN200	86	22704	457	243	749	697	219,1	1660,9	± 30.625,00	± 42.250,00
TBK017	2300KW	8"	DN200	89,9	23734	508	250	840	788	219,1	1670,9	± 35.750,00	± 49.000,00
TBK018	2650KW	10"	DN250	113,95	30083	559	265	915,5	863,5	273	1687	± 49.500,00	± 69.750,00
TBK019	3550KW	10"	DN250	152,65	40300	610	321	948	890	273	2137	± 59.750,00	± 81.000,00
TBK020	5100KW	12"	DN300	219,3	57895	800	356	1144	1080	323	2397,2	± 84.375,00	± 112.000,00

* ÜRÜNLERİMİZ - + %5 DEĞİŞKENLİK GÖSTEREBİLİR.



Merkez Ofis (Head Office): İstasyon Caddesi No:29 Bolvadin/Afyonkarahisar
Fabrika (Factory):Selçuklu Mahallesi Ticaret Bölgesi No:316 Bolvadin/Afyonkarahisar
Afyonkarahisar Şube (Branch): Karaman Mh. Alparslan Türkeş Cd. Hisar Apt. No:2/A Afyonkarahisar



Tel.:0 272 612 43 87
Fax: 0 272 612 63 80



web: www.teksanisi.com
e-mail: info@teksanisi.com



TORTU TUTUCU

DIRT SEPARATOR



MADE IN TURKEY

TR

Isıtma ve soğutma sistemlerdeki tesisatlarda kullanılan pislik ayırma aparatıdır. Kazan dönüşüne yerleştirilen tortu tutucu çamur, pislik ve korozyon atığı gibi tortuları tesisattan ayırır. Belirli aralıklarla tortu tutucunun alt kısmındaki vana açılarak biriken tortular kolayca tesisattan uzaklaştırılır. Böylelikle tesisattaki ısınma zorluğu ve verimsizliğin önüne geçilmiş olur.

EN

Dirt separators provide to collect dirt from the system. Dirt separator holds the dirt in its own reservoir to keep the systems efficiency optimized. Separator can be and must be cleaned periodically from the valve at the bottom.

teknik detaylar

technical details

KOD	GİRİŞ-ÇIKIŞ(İNÇ)	GİRİŞ-ÇIKIŞ(DN)	D(mm)	H(cm)	A(mm)	a(mm)	d(mm)	B(mm)	KAYNAKLI	FLANŞLI
TTT001	1"	DN25	89	23	189	159	33,7	81,9	₺1.150,00	
TTT002	1 1/4"	DN32	89	23	189	159	46	73	₺1.187,50	
TTT003	1 1/2"	DN40	114	24	214	184	48,3	79,15	₺1.625,00	₺2.250,00
TTT004	2"	DN50	114	37	234	204	60,3	115,15	₺1.950,00	₺2.725,00
TTT005	2 1/2"	DN65	169	40	289	259	73	133,5	₺2.325,00	₺3.225,00
TTT006	3"	DN80	219	38	409	379	88,9	174,5	₺3.462,50	₺4.500,00
TTT007	4"	DN100	219	50	409	379	114,3	187,15	₺4.050,00	₺5.250,00
TTT008	5"	DN125	273	56	463	433	141	210,5	₺5.300,00	₺6.875,00
TTT009	6"	DN150	323	65,4	513	483	168,3	261,15	₺7.225,00	₺9.200,00
TTT010	8"	DN200	406	96	698	646	219,1	349,6	₺16.325,00	₺19.200,00
TTT011	10"	DN250	559	119	897	839	273	476,5	₺29.500,00	₺36.525,00
TTT012	12"	DN300	610	137	954	890	323	516,5	₺46.875,00	₺59.375,00

mini tortu tutucu

mini dirt separator

KOD	GİRİŞ-ÇIKIŞ(İNÇ)	GİRİŞ-ÇIKIŞ(DN)	D(mm)	H(cm)	A(mm)	a(mm)	d(mm)	B(mm)	KAYNAKLI
TTM001	1"	DN25	75	10	110	33,7	33,7	27	₺1.300,00
TTM002	1 1/4"	DN32	89	11	122	42,4	42,4	31	₺1.350,00
TTM003	1 1/2"	DN40	89	12	134	48,3	48,3	34	₺1.775,00
TTM004	2"	DN50	89	12	134	60,3	60,3	40	₺2.175,00

* ÜRÜNLERİMİZ - + %5 DEĞİŞKENLİK GÖSTEREBİLİR.

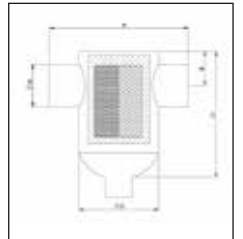
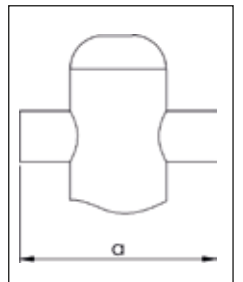
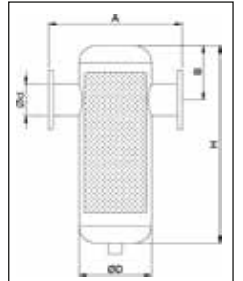

HAVA AYIRICI

AIR SEPARATOR



TR

Mekanik tesisatların en büyük düşmanlarından biri kavitasyondur. Kaviteasyon tesisatta devirdaim halindeki suyun farklı basınç noktalarından geçerken su içinde ergimiş halde bulunan havanın gaz haline gelerek pompa, boru ve tankların iç yüzeylerine zarar vermesidir. Kaviteasyonun başlıca zararları normalin üstünde gürültü, korozyon, pompa problemleri ve verim düşüklüğüdür. Bu sebeple hava ayırıcı kap tesisatın sağlıklı çalışması için hayati öneme sahiptir. Hava ayırıcı, tesisattaki ergimiş veya gaz halindeki havayı sudan ayırarak üst kısmındaki hava ventilleri sayesinde tesisattan uzaklaştırır.

EN

One of the biggest enemies of mechanic installation are the air bubbles which occur while water passes through from different pressure points. Those bubbles may cause cohesion in the system. Air separators evacuate those bubbles away from system rapidly.

teknik detaylar

technical details

KOD	GİRİŞ-ÇIKIŞ(İNÇ)	GİRİŞ-ÇIKIŞ(DN)	D(mm)	H(cm)	A(mm)	a(mm)	d(mm)	B(mm)	KAYNAKLI	FLANŞLI
THA001	1"	DN25	89	25	189	159	33,7	76,9	£1.287,50	
THA002	1 1/4"	DN32	89	26	189	159	42,4	73	£1.325,00	
THA003	1 1/2"	DN40	114	30	214	184	48,3	79,15	£1.850,00	£2.575,00
THA004	2"	DN50	114	390	234	204	60,3	105,15	£2.250,00	£3.125,00
THA005	2 1/2"	DN65	169	430	289	259	73	131,5	£2.700,00	£3.712,50
THA006	3"	DN80	219	510	409	379	88,9	189,45	£3.975,00	£5.150,00
THA007	4"	DN100	219	550	409	379	114,3	222,15	£4.450,00	£5.775,00
THA008	5"	DN125	273	590	463	433	141	275,5	£5.875,00	£7.450,00
THA009	6"	DN150	323	684	513	483	168,3	311,15	£7.950,00	£10.125,00
THA010	8"	DN200	406	930	698	646	273	465	£16.325,00	£19.200,00
THA011	10"	DN250	559	124	897	839	323	571,9	£29.500,00	£36.525,00
THA012	12"	DN300	610	127	960	890	323	596,5	£46.875,00	£59.375,00

mini hava ayırıcı

mini air separator

KOD	GİRİŞ-ÇIKIŞ(İNÇ)	GİRİŞ-ÇIKIŞ(DN)	D(mm)	H(cm)	A(mm)	a(mm)	d(mm)	B(mm)	KAYNAKLI
THM001	1"	DN25	75	10	110	33,7	33,7	27	£1.400,00
THM002	1 1/4"	DN32	89	11	122	42,4	42,4	31	£1.462,50
THM003	1 1/2"	DN40	89	12	134	48,3	48,3	34	£2.062,50
THM004	2"	DN50	89	12	134	60,3	60,3	40	£2.375,00

* ÜRÜNLERİMİZ - + %5 DEĞİŞKENLİK GÖSTEREBİLİR.



MADE IN TURKEY

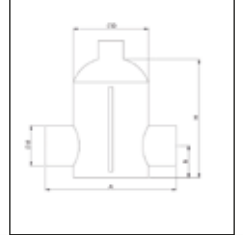
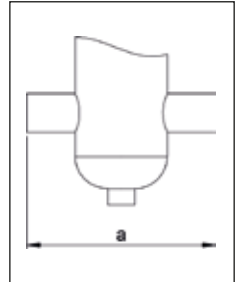
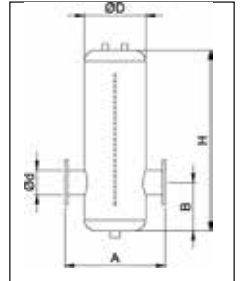



TORTU HAVA AYIRICI

DIRT & AIR SEPARATOR

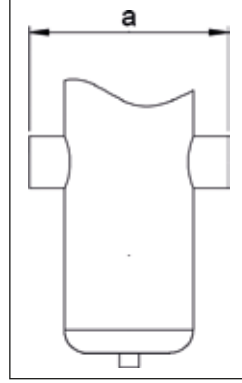
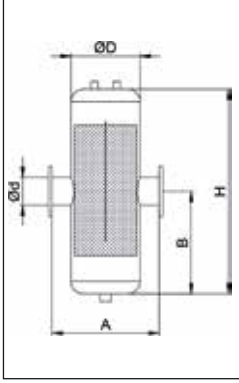

TR

Kazan sistemlerinde, yerden ısıtma sistemlerinde ve soğutma sistemlerinde tesisat suyunda oluşan hava ve tortuları ayıran mekanik seperatörlerdir. Tesisat suyunda oluşan tortu ve hava kabarcıkları (kavitasyon) tesisat, pompa ve kazanın verimini düşürüp ömrünü azaltır. Teksan tortu-hava ayırıcı kap tortu tutucu ve hava ayırıcı kapların görevini tek başına yerine getirir.

EN

As technical specifications required you may prefer Dirt & Air separator instead.



MADE IN TURKEY

teknik detaylar technical details

KOD	GİRİŞ-ÇIKIŞ(İNÇ)	GİRİŞ-ÇIKIŞ(DN)	D(mm)	H(cm)	A(mm)	a(mm)	d(mm)	B(mm)	KAYNAKLI	FLANŞLI
TTHK001	1"	DN25	89	25	189	159	33,7	76,9	₺1.525,00	
TTHK002	1 1/4"	DN32	89	26	189	159	42,4	73	₺1.575,00	
TTHK003	1 1/2"	DN40	114	30	214	184	48,3	79,15	₺2.225,00	₺3.075,00
TTHK004	2"	DN50	114	390	234	204	60,3	105,15	₺2.687,50	₺3.725,00
TTHK005	2 1/2"	DN65	169	430	289	259	73	131,5	₺3.200,00	₺4.450,00
TTHK006	3"	DN80	219	510	409	379	88,9	189,45	₺4.750,00	₺6.175,00
TTHK007	4"	DN100	219	550	409	379	114,3	222,15	₺5.325,00	₺6.925,00
TTHK008	5"	DN125	273	590	463	433	141	275,5	₺7.000,00	₺8.925,00
TTHK009	6"	DN150	323	684	513	483	168,3	311,15	₺9.525,00	₺12.150,00
TTHK010	8"	DN200	406	930	698	646	273	465	₺17.750,00	₺21.000,00
TTHK011	10"	DN250	559	124	897	839	323	571,9	₺32.250,00	₺39.750,00
TTHK012	12"	DN300	610	127	960	890	323	596,5	₺51.000,00	₺64.125,00

* ÜRÜNLERİMİZ - + %5 DEĞİŞKENLİK GÖSTEREBİLİR.



Merkez Ofis (Head Office): İstasyon Caddesi No:29 Bolvadin/Afyonkarahisar
Fabrika (Factory):Selçuklu Mahallesi Ticaret Bölgesi No:316 Bolvadin/Afyonkarahisar
Afyonkarahisar Şube (Branch): Karaman Mh. Alparslan Türkeş Cd. Hisar Apt. No:2/A Afyonkarahisar



Tel.:0 272 612 43 87
Fax: 0 272 612 63 80



web: www.teksanisi.com
e-mail: info@teksanisi.com



TORTU TUTUCU & MANYETİK FİLTRE

DIRT SEPARATOR & MAGNETIC FILTER



MADE IN TURKEY

TR

Tortu ve Manyetik filtre, Merkezi sistemlerde tortu tutucu işlevine ek olarak, sistem içerisindeki sızıda bulunan metal parçacıkları toplarlar. flanşlı ve dişli olarak sisteme montajı yapılır ihtiyaca göre gövdede bulunan neodyum çubuk mıknatıs adetleri artırılıp eksiltilebilir mıknatıslar gövdenin dışında bulunan piriç tapa sayesinde mıknatıslar, manyetik kir parçacıklarından arındırmak için çıkarılabilir. Bu sayede sistemde demir parçası, toru, çamur ve pislik tek ürün kullanılarak arındırılmış olur tortu çamur ve pislik temizliği ürün altında bulunan tahliye vanasından boşaltımı sağlanır

EN

Dirt separators and magnetic filter collects toxic metal in the system center, in addition to the torture inspection service in central systems. It is made systematically designed as a teaching method. These system systems are purified from iron part, toru, single devices and discharged from the drain valve consisting of the product purified from dirt cleaning.

teknik detaylar
technical details

KOD	GİRİŞ-ÇIKIŞ (İNÇ)	GİRİŞ-ÇIKIŞ (DN)	D(mm)	H(cm)	A(mm)	a(mm)	d(mm)	B(mm)	KAYNAKLI	FLANŞLI
TMF001	1"	DN25	89	23	189	159	33,7	81,9	₺5.125,00	
TMF002	1 1/4"	DN32	89	23	189	159	46	73	₺5.250,00	
TMF003	1 1/2"	DN40	114	24	214	184	48,3	79,15	₺5.375,00	₺6.375,00
TMF004	2"	DN50	114	37	234	204	60,3	115,15	₺6.000,00	₺6.800,00
TMF005	2 1/2"	DN65	169	40	289	259	73	133,5	₺6.475,00	₺7.250,00
TMF006	3"	DN80	219	38	409	379	88,9	174,5	₺8.625,00	₺9.875,00
TMF007	4"	DN100	219	50	409	379	114,3	187,15	₺9.050,00	₺10.500,00
TMF008	5"	DN125	273	56	463	433	141	210,5	₺10.300,00	₺11.875,00
TMF009	6"	DN150	323	65,4	513	483	168,3	261,15	₺13.475,00	₺19.200,00
TMF010	8"	DN200	406	96	698	646	219,1	349,6	₺21.325,00	₺26.250,00
TMF011	10"	DN250	559	119	897	839	273	476,5	₺31.250,00	₺39.750,00
TMF012	12"	DN300	610	137	954	890	323	516,5	₺45.000,00	₺52.500,00

* ÜRÜNLERİMİZ - + %5 DEĞİŞKENLİK GÖSTEREBİLİR.



Merkez Ofis (Head Office): İstasyon Caddesi No:29 Bolvadin/Afyonkarahisar
Fabrika (Factory):Selçuklu Mahallesi Ticaret Bölgesi No:316 Bolvadin/Afyonkarahisar
Afyonkarahisar Şube (Branch): Karaman Mh. Alparslan Türkeş Cd. Hisar Apt. No:2/A Afyonkarahisar



Tel.:0 272 612 43 87
Fax: 0 272 612 63 80



web: www.teksanisi.com
e-mail: info@teksanisi.com

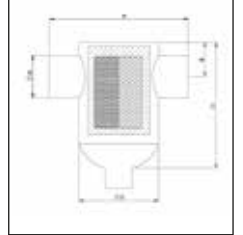
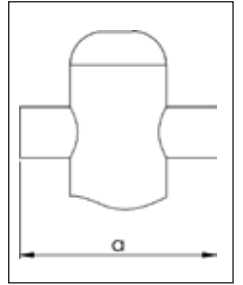
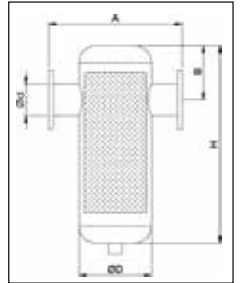



BİRLEŞİK KAP & MANYETİK FİLTRE

COMBINED SEPARATOR & MAGNETIC FILTER



TR

Birleşik kap ve manyetik filtre merkezi sistemlerde denge kabı, hava ayırıcı ve tortu tutucu işlevine ek olarak, sistem içerisindeki sıvıda bulunan metal parçacıkları toplarlar. Flanşlı ve Dişli olarak sisteme montajı yapılır ihtiyaca göre gövdede bulunan neodyum çubuk mıknatıs adetleri artırılıp eksiltilebilir mıknatıslar gövdenin dışında bulunan pirinç tapa sayesinde sökülüp takılabilir mıknatıslar, manyetik kir parçacıklarından arındırmak için çıkarılıp temizlenmesi gerekir. Bu ürün sayesinde denge kabı ve hava ayırıcı işlevini de yerine getirir, sistemde demir parçası, tortu, çamur ve pislik tek ürün kullanılarak arındırılmış olur tortu çamur ve pislik temizliği ürün altında bulunan tahliye vanasından boşaltımı sağlar.

EN

Combined vessel and magnetic filter In central systems, in addition to the balance vessel, air separator and sediment holder, it collects metal particles in the liquid in the system. It is mounted to the system as flanged and threaded. The number of neodymium bar magnets in the body can be increased or decreased depending on the need, magnets that can be removed and cleaned thanks to the brass plug located outside the body, magnetic dirt particles must be removed and cleaned. Thanks to this product, it performs the operation of the balance tank and air separator, the iron part, tou, mud and dirt are purified by using a single product in the system.

teknik detaylar

technical details

KOD	GÜÇ	GİRİŞ-ÇIKIŞ (İNÇ)	GİRİŞ-ÇIKIŞ(DN)	M3	GALON	D(mm)	H(cm)	A(mm)	a(mm)	d(mm)	B(mm)	KAYNAKLI	FLANŞLI
TBMF001	40KW	1"	DN25	Haz.00	454	76	35	173	159	33,7	203	₺ 6.375,00	
TBMF002	50KW	1 1/4"	DN32	Oca.00	567	89	34	189	159	46	214	₺ 6.625,00	
TBMF003	70KW	1 1/2"	DN40	3,01	794	89	39	239	209	48,3	251,7	₺ 6.725,00	₺ 8.500,00
TBMF004	115KW	2"	DN50	4,95	1306	114	53	264	234	60,3	319,7	₺ 8.937,50	₺ 11.375,00
TBMF005	135KW	2 1/2"	DN65	5,8	1531	141	60,4	311	281	76,1	353,9	₺ 9.750,00	₺ 12.750,00
TBMF006	185KW	2 1/2"	DN65	7,95	2099	169	71	359	329	76,1	403,9	₺ 11.000,00	₺ 13.925,00
TBMF007	235KW	3"	DN80	10,1	2667	169	77	359	329	88,9	451,1	₺ 12.375,00	₺ 15.675,00
TBMF008	310KW	3"	DN80	13,33	3519	219	78	409	379	88,9	451,1	₺ 13.375,00	₺ 16.375,00
TBMF009	360KW	4"	DN100	15,48	4087	219	88	409	379	114,3	495,7	₺ 13.875,00	₺ 17.000,00
TBMF010	510KW	4"	DN100	21,93	5790	273	90	463	433	114,3	455,6	₺ 14.950,00	₺ 18.125,00
TBMF011	635kw	5"	DN125	27,3	7207	273	116	463	433	139,7	730,2	₺ 16.375,00	₺ 20.300,00
TBMF012	760KW	5"	DN125	32,68	2652	273	138	463	433	139,7	910,3	₺ 17.600,00	₺ 21.700,00
TBMF013	900KW	6"	DN150	38,7	10217	323	143,4	513	483	168,3	911,7	₺ 22.000,00	₺ 27.250,00
TBMF014	1150kw	6"	DN150	49,45	13055	355	179	585	555	168,3	1212,7	₺ 25.875,00	₺ 32.250,00
TBMF015	1600KW	8"	DN200	68,8	18163	406	208	672	628	219,1	1371,9	₺ 32.000,00	₺ 42.375,00
TBMF016	2000kw	8"	DN200	86	22704	457	243	749	697	219,1	1660,9	₺ 35.625,00	₺ 47.250,00
TBMF017	2300KW	8"	DN200	89,9	23734	508	250	840	788	219,1	1670,9	₺ 40.750,00	₺ 54.000,00
TBMF018	2650KW	10"	DN250	113,95	30083	559	265	915,5	863,5	273	1687	₺ 54.500,00	₺ 74.375,00
TBMF019	3550KW	10"	DN250	152,65	40300	610	321	948	890	273	2137	₺ 64.750,00	₺ 86.000,00
TBMF020	5100KW	12"	DN300	219,3	57895	800	356	1144	1080	323	2397,2	₺ 89.375,00	₺ 117.000,00

* ÜRÜNLERİMİZ - + %5 DEĞİŞKENLİK GÖSTEREBİLİR.



MADE IN TURKEY

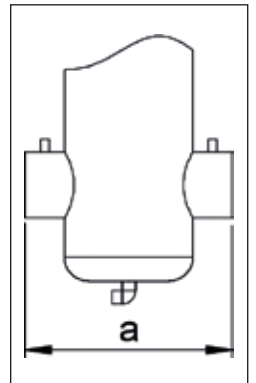
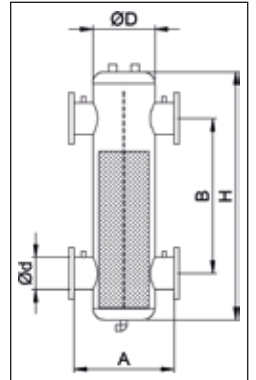



TEKSAN[®]
ISI & DOĞALGAZ MÜHENDİSLİK



Nötralizasyon Tankları

• neutralization tanks



www.teksanisi.com



NÖTRALİZASYON TANKI

NEUTRALIZATION TANK

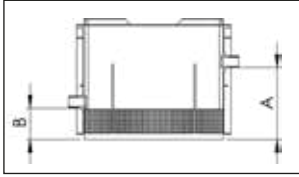
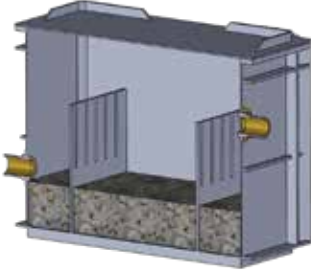

TR

Yanma sırasında meydana gelen kondensasyon ve baca gazlarının yogusması nedeni ile pH degerleri düşer kondens asidi ortaya çıkar. Kondense asidi oldukça ciddi ekolojik problemlere sebep olurken aynı zamanda ekonomizör , kazan ve mevcut boru tesisatı üzerinde ciddi hasarlara ve korozyona sebep olur. Nötralizasyon tankı bu atıkların pH degerini nötr hale getirerek bu problemi önler Nötralizasyon islemi için en uygun yöntem asidik derecedeki kimyasal atığın kalsiyum karbonat içeren dilimlerle nötrleşme işlemidir. Kalsiyum karbonatlar (CaCO₃) suyun içerisinde asitlerle tepkimeye girerek zararsız doğal tuzlarla CO₂ açığa çıkar. Tuzlar tortular halinde dibeye çökerken CO₂ ise suda çözünerek karbonik asitleri oluşturur. Oluşan karbonik asitler alkali atıkları pH 3'ten pH 5,5 pH 8,5 dereceleri arasına kadar yükselterek nötralize eder. Böylece atık su giderleri , kazan dairesi tesisatı ve en önemlisi ekolojisyeme ciddi zararlar verebilecek kimyasallar zararsız hale gelmiş olur.

EN

Due to the variation temperature of the Boiler and funnel system cause condensation water at heating systems. This low pH valued acidic and toxic water must be purified then drained to sewage systems The Teksan neutralization tank prevent the nature and the installation from this acidic and toxic water by turning them in to harmless and pH optimized water . The neutralization tank must be placed before this toxic water entering the sewage.

teknik detaylar technical details

KOD code	GÜÇ power kw	BAĞLANTI in - out inç	D cm	H cm	C cm	B cm	A cm	FİYAT PRICE
TNP 001	350 KW	1"	40	30	22	7	15	₺1.275,00
TNP 002	550 KW	1"	40	30	30	10	20	₺1.437,00
TNP 003	800 KW	1"	40	30	30	10	20	₺2.050,00
TNP 004	1100 KW	1"	40	40	30	10	20	₺2.550,00
TNP 005	1600 KW	1 1/4"	40	40	30	10	20	₺3.000,00
TNP 006	2800 KW	1 1/4"	60	40	27	9	18	₺4.800,00
TNP 007	3900 KW	1 1/2"	60	40	43	15	29	₺6.525,00



MADE IN TURKEY

* ÜRÜNLERİMİZ - + %5 DEĞİŞKENLİK GÖSTEREBİLİR.



Merkez Ofis (Head Office): İstasyon Caddesi No:29 Bolvadin/Afyonkarahisar
Fabrika (Factory):Selçuklu Mahallesi Ticaret Bölgesi No:316 Bolvadin/Afyonkarahisar
Afyonkarahisar Şube (Branch): Karaman Mh. Alparslan Türkeş Cd. Hisar Apt. No:2/A Afyonkarahisar



Tel.:0 272 612 43 87
Fax: 0 272 612 63 80



web: www.teksanisi.com
e-mail: info@teksanisi.com

NÖTRALİZASYON TANKI

NEUTRALIZATION TANK

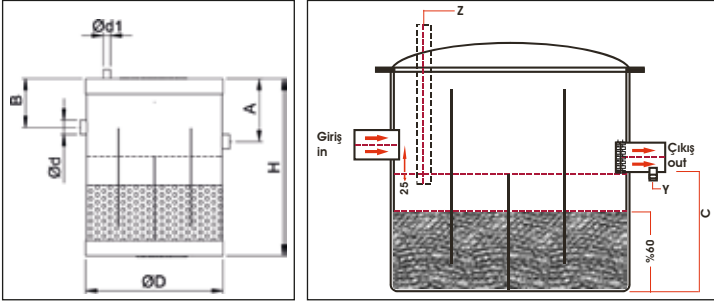

TR

Yanma sırasında meydana gelen kondensasyon ve baca gazlarının yogusması nedeni ile pH değerleri düşer kondens asidi ortaya çıkar. Kondens asidi oldukça ciddi ekolojik problemlere sebep olurken aynı zamanda ekonomizör, kazan ve mevcut boru tesisatı üzerinde ciddi hasarlara ve korozyona sebep olur. Nötralizasyon tankı bu atıkların pH değerini nötr hale getirerek bu problemi önler. Nötralizasyon işlemi için en uygun yöntem asidik derecedeki kimyasal atığın kalsiyum karbonat içeren dilimlerle nötrleşme işlemidir. Kalsiyum karbonatlar ($CaCO_3$) suyun içerisinde asitler ile tepkimeye girerek zararsız doğal tuzlarla CO_2 açığa çıkar. Tuzlar tortular halinde dibine çökerken CO_2 ise suda çözünerek karbonik asitleri oluşturur. Oluşan karbonik asitler alkali atıkları pH 3'ten pH 5,5, pH 8,5 dereceleri arasına kadar yükselterek nötralize eder. Böylece atık su giderleri, kazan dairesi tesisatı ve en önemlisi ekolojisyeme ciddi zararlar verebilecek kimyasallar zararsız hale gelmiş olur.

EN

Due to the variation temperature of the Boiler and funnel system cause condensation water at heating systems. This low pH valued acidic and toxic water must be purified then drained to sewage systems. The Teksan neutralization tank prevents the nature and the installation from this acidic and toxic water by turning them into harmless and pH optimized water. The neutralization tank must be placed before this toxic water entering the sewage.

teknik detaylar technical details

KOD code	GÜÇ power KW	GİRİŞ - ÇIKIŞ in - out inç	MANŞON ejection inç	D cm	H cm	B cm	A cm	FİYAT PRICE
TNT 001	350 KW	1"	1/2"	40	30	14	16,5	₺5.100,00
TNT 002	550 KW	1"	1/2"	40	35	14	16,5	₺5.750,00
TNT 003	800 KW	1"	1/2"	40	40	14	16,5	₺8.200,00
TNT 004	1100 KW	1"	1/2"	40	45	14	16,5	₺10.200,00
TNT 005	1600 KW	1"	1/2"	40	50	14	16,5	₺12.000,00
TNT 006	2800 KW	1 1/4"	1/2"	40	60	14	16,5	₺19.200,00
TNT 007	3900 KW	1 1/2"	1/2"	50	40	14	16,5	₺26.100,00

* ÜRÜNLERİMİZ - + %5 DEĞİŞKENLİK GÖSTEREBİLİR.



MADE IN TURKEY



Merkez Ofis (Head Office): İstasyon Caddesi No:29 Bolvadin/Afyonkarahisar
Fabrika (Factory): Selçuklu Mahallesi Ticaret Bölgesi No:316 Bolvadin/Afyonkarahisar
Afyonkarahisar Şube (Branch): Karaman Mh. Alparslan Türkeş Cd. Hisar Apt. No:2/A Afyonkarahisar



Tel.: 0 272 612 43 87
Fax: 0 272 612 63 80



web: www.teksanisi.com
e-mail: info@teksanisi.com



TEKSAN[®]
ISI & DOĞALGAZ MÜHENDİSLİK

BOYLER
BOILER

AKÜMÜLASYON TANKI
ACCUMULATION TANK

GENİŞLEME TANKI
EXPANSION TANK

YAĞ TUTUCU
OIL SEPARATOR

KASKAD KAZAN BAĞLANTI SETİ
CASCAD BOILER CONNECTION SET

Boyerler & Tanklar

boiler & tanks



www.teksanisi.com

BOYLER

BOILER



MADE IN TURKEY

TR

Teksan boyler ısıtma cihazlarından elde edilen sıcak suyu ayrı bir bölümde kullanım suyu ile karıştırmadan istenilen litrede depolama görevini kullanıcının isteği doğrultusunda sıcak su sunar.

Teksan boyler farklı modellere sahip olup kılıflı, kılıfsız, dış yüzeyi paslanmaz olarak üretimi yapılmaktadır. İç depolama kısmı galvaniz veya emaye olup, ekonomik ve hızlı ısınma konusunda siz ve sevdikleriniz bu rahatlığın tadını çıkarın.

EN

Teksan boiler is use for heating usage water at another division than central heating system by various capacity strogas. Teksan boilers have various models such as sheated , unshated and stainless steel covered. Inside tank made by galvanized steel or enamel. Teksan boilers are the best solutions at cheap and fast usage water heating

teknik detaylar

technical details

KOD	KAPASİTE	ÜRÜN CİNCİ	ÇAP	BOY	MAGNEZYUM ANOT	SU GİRİŞ ÇIKIŞI	KALORİFER HATTI	ELEKTRİK BAĞLANTISI	TEMİZLEME FLANŞI	FİYAT
TTB 001	100 Lt.	TEK SERPANTİN	500	1100	1 1/4"	3/4"	1"	1 1/4"	DN 100	₺18.460,00
TTB 002	160 Lt.	TEK SERPANTİN	600	1100	1 1/4"	3/4"	1 1/4"	1 1/4"	DN 100	₺21.190,00
TTB 003	200 Lt.	TEK SERPANTİN	600	1300	1 1/4"	1"	1 1/4"	1 1/4"	DN 100	₺24.570,00
TTB 004	300 Lt.	TEK SERPANTİN	700	1150	1 1/4"	1"	1 1/4"	1 1/4"	DN 100	₺30.810,00
TTB 005	400 Lt.	TEK SERPANTİN	700	1900	1 1/4"	1 1/4"	1 1/4"	1 1/4"	DN 100	₺42.120,00
TTB 006	500 Lt.	TEK SERPANTİN	700	2050	1 1/4"	1 1/4"	1 1/4"	1 1/4"	DN 100	₺48.100,00
TTB 007	600 Lt.	TEK SERPANTİN	700	2100	1 1/4"	1 1/4"	1 1/4"	1 1/4"	DN 100	₺66.300,00
TTB 008	800 Lt.	TEK SERPANTİN	910	2100	1 1/4"	1 1/4"	1 1/4"	1 1/4"	DN 100	₺84.500,00
TTB 009	1000 Lt.	TEK SERPANTİN	1000	1900	1 1/4"	1 1/4"	1 1/4"	1 1/4"	DN 100	₺91.500,00
TTB 010	1500 Lt.	TEK SERPANTİN	1250	2100	1 1/4"	1 1/4"	1 1/4"	1 1/4"	DN 100	₺135.200,00
TTB 011	2000 Lt.	TEK SERPANTİN	1250	2300	1 1/4"	1 1/4"	1 1/4"	1 1/4"	DN 100	₺153.400,00

* ÜRÜNLERİMİZ - + %5 DEĞİŞKENLİK GÖSTEREBİLİR.

KOD	KAPASİTE	ÜRÜN CİNCİ	ÇAP	BOY	MAGNEZYUM ANOT	SU GİRİŞ ÇIKIŞI	KALORİFER HATTI	ELEKTRİK BAĞLANTISI	TEMİZLEME FLANŞI	FİYAT
TÇB 001	100 Lt.	ÇİFT SERPANTİN	500	1100	1 1/4"	3/4"	1"	1 1/4"	DN 100	₺20.540,00
TÇB 002	160 Lt.	ÇİFT SERPANTİN	600	1100	1 1/4"	3/4"	1 1/4"	1 1/4"	DN 100	₺22.360,00
TÇB 003	200 Lt.	ÇİFT SERPANTİN	600	1300	1 1/4"	1"	1 1/4"	1 1/4"	DN 100	₺24.700,00
TÇB 004	300 Lt.	ÇİFT SERPANTİN	700	1150	1 1/4"	1"	1 1/4"	1 1/4"	DN 100	₺32.110,00
TÇB 005	400 Lt.	ÇİFT SERPANTİN	700	1900	1 1/4"	1 1/4"	1 1/4"	1 1/4"	DN 100	₺44.590,00
TÇB 006	500 Lt.	ÇİFT SERPANTİN	700	2050	1 1/4"	1 1/4"	1 1/4"	1 1/4"	DN 100	₺53.300,00
TÇB 007	600 Lt.	ÇİFT SERPANTİN	700	2100	1 1/4"	1 1/4"	1 1/4"	1 1/4"	DN 100	₺61.800,00
TÇB 008	800 Lt.	ÇİFT SERPANTİN	910	2100	1 1/4"	1 1/4"	1 1/4"	1 1/4"	DN 100	₺88.660,00
TÇB 009	1000 Lt.	ÇİFT SERPANTİN	1000	1900	1 1/4"	1 1/4"	1 1/4"	1 1/4"	DN 100	₺100.880,00
TÇB 010	1500 Lt.	ÇİFT SERPANTİN	1250	2100	1 1/4"	1 1/4"	1 1/4"	1 1/4"	DN 100	₺142.220,00
TÇB 011	2000 Lt.	ÇİFT SERPANTİN	1250	2300	1 1/4"	1 1/4"	1 1/4"	1 1/4"	DN 100	₺167.960,00





AKÜMÜLASYON TANKI

ACCUMULATION TANK

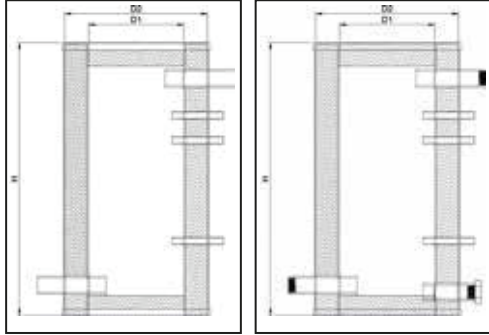

TR

Akümülyasyon tankları ısıtma veya soğutma sistemlerinde ısıtılmış veya soğutulmuş kullanım suyunu hijyenik olarak depolayan tanklardır.

Güneş enerjisi, ısı pompası, eşanjör, boyler, chiller, fancoil vb. ısı değıştirici cihazların ardına monte edilir. Ayrıca kullanım suyu depolanması harici fazla sıcak su tüketimi olan tesislerde ve ısı gerektiren prosesler için suyun depolanmasında kullanılır.

EN

The accumulation tanks can be use at heating or cooling systems. which is saves hot or cold usage water by the hygienically way

 **teknik detaylar**
technical details



MADE IN TURKEY

KOD	KAPASİTE	ÇAP	BOY	MAGNEZYUM ANOT	SU GİRİŞ ÇIKIŞI	KALORİFER HATTI	ELEKTRİK BAĞLANTISI	TEMİZLEME FLANŞI	FİYAT
TTB 001	50 Lt.	40	75				1 1/4"		₺12.250,00
TTB 002	100 Lt.	600	1100	1 1/4"	3/4"	1 1/4"	1 1/4"	DN 100	₺14.800,00
TTB 003	160 Lt.	600	1100	1 1/4"	1"	1 1/4"	1 1/4"	DN 100	₺16.900,00
TTB 004	200 Lt.	700	1300	1 1/4"	1"	1 1/4"	1 1/4"	DN 100	₺18.900,00
TTB 005	300 Lt.	700	1150	1 1/4"	1 1/4"	1 1/4"	1 1/4"	DN 100	₺22.750,00
TTB 006	400 Lt.	700	1900	1 1/4"	1 1/4"	1 1/4"	1 1/4"	DN 100	₺29.500,00
TTB 007	500 Lt.	700	2050	1 1/4"	1 1/4"	1 1/4"	1 1/4"	DN 100	₺35.000,00
TTB 008	600 Lt.	910	2100	1 1/4"	1 1/4"	1 1/4"	1 1/4"	DN 100	₺49.250,00
TTB 009	800 Lt.	1000	2100	1 1/4"	1 1/4"	1 1/4"	1 1/4"	DN 100	₺64.400,00
TTB 010	1000 Lt.	1250	1900	1 1/4"	1 1/4"	1 1/4"	1 1/4"	DN 100	₺72.500,00
TTB 011	1500 Lt.	1250	2100	1 1/4"	1 1/4"	1 1/4"	1 1/4"	DN 100	₺102.000,00
TTB 012	2000 Lt.	1250	2300	1 1/4"	1 1/4"	1 1/4"	1 1/4"	DN 100	₺122.500,00

* ÜRÜNLERİMİZ - + %5 DEĞİŞKENLİK GÖSTEREBİLİR.



Merkez Ofis (Head Office): İstasyon Caddesi No:29 Bolvadin/Afyonkarahisar
Fabrika (Factory):Selçuklu Mahallesi Ticaret Bölgesi No:316 Bolvadin/Afyonkarahisar
Afyonkarahisar Şube (Branch): Karaman Mh. Alparslan Türkeş Cd. Hisar Apt. No:2/A Afyonkarahisar



Tel.:0 272 612 43 87
Fax: 0 272 612 63 80



web: www.teksanisi.com
e-mail: info@teksanisi.com



GENLEŞME TANKI

EXPANSION TANK

TR

Genleşme tankları, değişken sıcaklığın ve basıncın olduğu sistemlerde genleşme hacminin ayarlanmasını sağlar sistemdeki basıncı eşitler, içerisindeki EPDM membran ile iki bölüme ayrılmış tanklardır. Sistemin çalışma şekli - su sisteme girdiğinde sistemdeki basınç artar. Bu basınç arttıkça, genleşme tankında bulunan membran dış gövde ile arasında bulunan basınçlı hava sayesinde sisteme su geldiğinde tank içerisindeki hava sıkışır ve fazla suyun girmesi için alan oluşur sistemdeki basınç ayarını düzenler ve olası bir tehlikeyi engellemeye yardımcı olur. Bu şekilde Sistemdeki aşırı basınç azalır

EN

Multifunctional sanitary vessels are designed to be filtered both into sanitary system as expansion tanks, suitable to absorb the water expansion volume generated by a changing temperature, as well as tanks for cold water sanitary systems.



MADE IN TURKEY

* ÜRÜNLERİMİZ - + %5 DEĞİŞKENLİK GÖSTEREBİLİR.

teknik detaylar
technical details

Technical Specifications	
Production vessel volumes	2 - 5000 lt.
Max. working pressure	10 bar
Operating temperature	-10 / +100°C
Factory precharge (2-80 lt.)	3 bar
Factory precharge (100-5000lt)	4 bar
Raw material	High grade carbon steel
Membrane material (bladder)	EPDM/BUTYL
Coating (cover)	Electro-static powder coating
Types of vessels	Vertical, vertical with legs
Certifications	CE 97/23 PED directive, WRAS, EN 13831
Area of use	Multi water applications
Color	Blue / Red / White

KOD/CODE	ÜRÜN ADI/PRODUCT NAME	FİYAT/PRICE
TGT 001	8 LT AYAKSIZ DİK TANK	\$ 36,20
TGT 002	12 LT AYAKSIZ DİK TANK	\$ 38,25
TGT 003	18 LT AYAKSIZ DİK TANK	\$ 45,75
TGT 004	24 İTALYAN TİPİ BASIK KÜRE TANK	\$ 45,75
TGT 005	24 LT AYAKSIZ DİK TANK	\$ 48,75
TGT 006	24 LT AYAKLI ŞASE YATIK TANK	\$ 62,25
TGT 007	35 LT AYAKLI DİK TANK	\$ 66,75
TGT 008	50 LT AYAKLI DİK TANK	\$ 90,00
TGT 009	50 LT AYAKLI ŞASE YATIK TANK	\$ 90,00
TGT 010	60 LT AYAKLI DİK TANK	\$ 108,75
TGT 011	60 LT AYAKLI ŞASELİ YATIK TANK	\$ 108,75
TGT 012	80 LT AYAKLI DİK TANK	\$ 144,75
TGT 013	80 LT AYAKLI ŞASELİ YATIK TANK	\$ 144,75
TGT 014	100 LT AYAKLI DİK TANK MANOMETRELİ	\$ 170,25
TGT 015	100 LT AYAKLI ŞASELİ YATIK TANK	\$ 170,25
TGT 016	150 LT AYAKLI DİK TANK MANOMETRELİ	\$ 240,75
TGT 017	200 LT AYAKLI DİK TANK MANOMETRELİ	\$ 318,00
TGT 018	300 LT AYAKLI DİK TANK MANOMETRELİ	\$ 393,75
TGT 019	500 LT AYAKLI DİK TANK MANOMETRELİ	\$ 590,25
TGT 020	750 LT AYAKLI DİK TANK MANOMETRELİ	\$ 833,25
TGT 021	1000 LT AYAKLI DİK TANK MANOMETRELİ	\$ 1.211,25
TGT 022	1500 AYAKLI DİK TANK MANOMETRELİ	\$ 2.055,00
TGT 023	2000 LT AYAKLI DİK TANK MANOMETRELİ	\$ 2.670,00



YAĞ TUTUCU

OIL SEPERATOR



teknik detaylar

technical details

PASLANMAZ YAĞ TUTUCU
STAINLESS OIL SEPERATOR

KOD code	KAPASİTE capacity	GİRİŞ-ÇIKIŞ in-out inç.	A cm	B cm	H cm	FİYAT PRICE
TYT 001	7 lt.	Q 50	40	35	35	₺11.500,00
TYT 002	15 lt.	Q 50	70	35	40	₺13.900,00
TYT 003	20 lt.	Q 50	75	45	40	₺17.300,00
TYT 004	48 lt.	Q 50	90	50	45	₺29.800,00

teknik detaylar

technical details

PLASTİK YAĞ TUTUCU
PLASTIC OIL SEPERATOR

KOD code	KAPASİTE capacity	GİRİŞ-ÇIKIŞ in-out inç.	A cm	B cm	H cm	FİYAT PRICE
TYP 001	5 lt.	Q 50	40	30	22	₺5.000,00
TYP 002	7 lt.	Q 50	40	30	30	₺5.650,00
TYP 003	10 lt.	Q 50	40	40	30	₺6.900,00
TYP 004	12 lt.	Q 50	60	40	27	₺8.200,00
TYP 003	20 lt.	Q 50	60	40	43	₺10.310,00

TR

Atık yağların herhangi bir arıtma olmadan direk kanalizasyona gönderilmesi ekolojik denge için çok tehlikelidir. Çünkü bir litre atık yağ on binlerce litre temiz suyu kirletebilir. Ayrıca donan atık yağlar tesisat giderlerinde tıkanıklıklara sebep olabilir. Teksan yağ tutucu atık yağları filtreleyerek doğaya ve tesisata verebileceği zararı önler

EN

The waste oils are seriously harming the nature and environment. Many countries strictly obey the use of Oil separators. Oil separators block the wasted oil in its own reservoir and saves the nature and environment. It must be cleaned regularly.

HAVA TÜPÜ

AIR TUBE

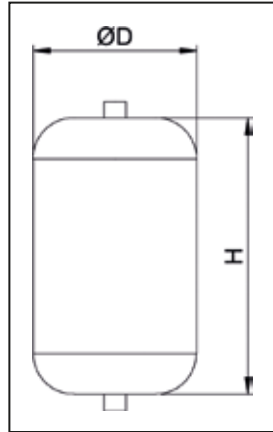

MADE IN TURKEY

TR

Hava tüpü kalorifer tesisatındaki dolaşan suda oluşan havayı içersinde toparlıyıp , üst tarafındaki manşona bağlanan otomatik hava atıcı purjör sayesinde dışarıya atan yardımcı üründür

EN

Air tube evacuate the air from heating systems.

teknik detaylar

technical details

KOD code	KAPASİTE capacity	GİRİŞ-ÇIKIŞ inç.	H cm	D cm	FİYAT PRICE
THT 001	2 lt.	1/2"	17	14	₺437,50
THT 002	3 lt.	1/2"	17	15	₺462,50
THT 003	5 lt.	1/2"	19	18	₺487,50
THT 004	10 lt.	1/2"	25	13	₺725,00
THT 005	15 lt.	1/2"	27	27	₺1.050,00
THT 006	20 lt.	1/2"	32	25	₺1.425,00
THT 007	30 lt.	1/2"	45	38	₺2.125,00

* ÜRÜNLERİMİZ - + %5 DEĞİŞKENLİK GÖSTEREBİLİR.





KASKAD KAZAN BAĞLANTI SETİ

CASCADE BOILER CONNECTION SET



TKKS 001
KASKAD KAZAN
TEKLİ BAĞLANTI SETİ
KASKAD BOILER
SINGLE CONNECTION

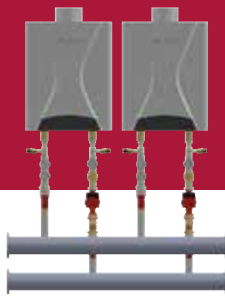

TKKS 002
KASKAD KAZAN
İKİLİ BAĞLANTI SETİ
KASKAD BOILER
DOUBLE CONNECTION

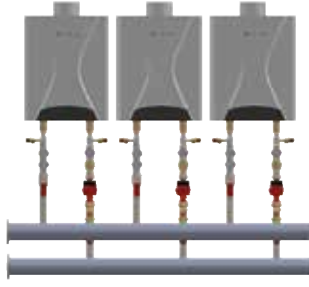

TKKS 003
KASKAD KAZAN
ÜÇLÜ BAĞLANTI SETİ
KASKAD BOILER
TRIBLE CONNECTION

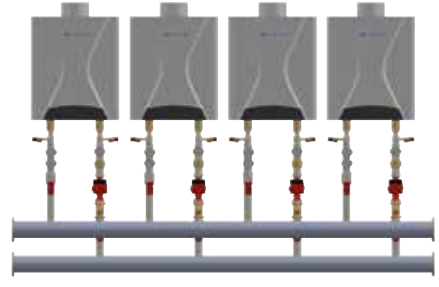

TKKS 004
KASKAD KAZAN
DÖRTLÜ BAĞLANTI SETİ
KASKAD BOILER
QUADRUPLE CONNECTION

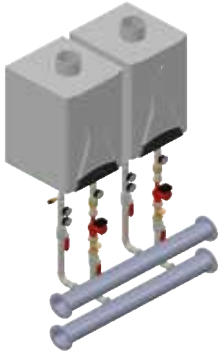

KOD code	ÜRÜN ADI product name	FİYAT PRICE
TKKS 001	KASKAD KAZAN TEKLİ BAĞLANTI SETİ / KASKAD BOILER SINGLE CONNECTION	FİYAT SORUNUZ
TKKS 002	KASKAD KAZAN İKİLİ BAĞLANTI SETİ / KASKAD BOILER DOUBLE CONNECTION	FİYAT SORUNUZ
TKKS 003	KASKAD KAZAN ÜÇLÜ BAĞLANTI SETİ / KASKAD BOILER TRIBLE CONNECTION	FİYAT SORUNUZ
TKKS 004	KASKAD KAZAN DÖRTLÜ BAĞLANTI SETİ / KASKAD BOILER QUADRUPLE CONNECTION	FİYAT SORUNUZ

KOD code	ÜRÜN ADI product name	KOD code
TKKH 001	KASKAD KAZAN HİDROLİK BAĞLANTI SETİ / KASKAD BOILER HYDRAULIC CONNECTION SET	FİYAT SORUNUZ

KOD code	ÜRÜN ADI product name	FİYAT PRICE
TKKK 001	KASKAD KAZAN TEKLİ KOLLEKTÖR GRUBU CASCADE BOILER SINGLE COLLECTOR GROUP	FİYAT SORUNUZ
TKKK002	KASKAD KAZAN İKİLİ KOLLEKTÖR GRUBU CASCADE BOILER DOUBLE COLLECTOR GROUP	FİYAT SORUNUZ
TKKK 003	KASKAD KAZAN ÜÇLÜ KOLLEKTÖR GRUBU CASCADE BOILER TRIPLE COLLECTOR GROUP	FİYAT SORUNUZ
TKKK 004	KASKAD KAZAN DÖRTLÜ KOLLEKTÖR GRUBU CASCADE BOILER QUADRUPLE COLLECTOR GROUP	FİYAT SORUNUZ

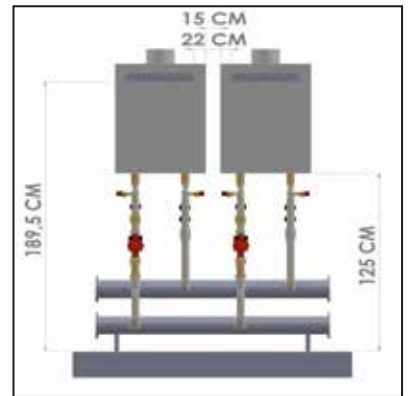

* ÜRÜNLERİMİZ - + %5 DEĞİŞKENLİK GÖSTEREBİLİR.





DÜZ FLANŞ

FLAT FLANGE

PN 16

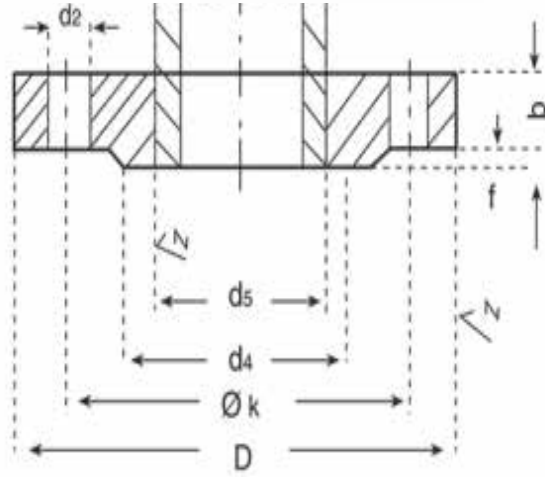

MADE IN TURKEY



KOD	inc	DN	İÇ ÇAP	DIŞ ÇAP	AGIRLIK	FİYAT
TFD001	1 1/4"	DN 32	15 mm	14 mm	1,35	₺162,50
TFD002	1 1/2"	DN 40	15 mm	14 mm	1,55	₺180,00
TFD003	2"	DN 50	15 mm	14 mm	1,8	₺230,00
TFD004	2 1/2"	DN 65	15 mm	14 mm	2,2	₺260,00
TFD005	3"	DN 80	15 mm	14 mm	2,25	₺300,00
TFD006	4"	DN 100	15 mm	14 mm	2,4	₺367,50
TFD007	5"	DN 125	15 mm	14 mm	3	₺455,00
TFD008	6"	DN 150	15 mm	14 mm	3,85	₺587,50
TFD009	8"	DN 200	20 mm	18,50 mm	6,55	₺1.275,00
TFD010	10"	DN 250	23 mm	22 mm	11	₺2.975,00
TFD011	12"	DN 300	23 mm	22 mm	15	₺3.925,00

* ÜRÜNLERİMİZ - + %5 DEĞİŞKENLİK GÖSTEREBİLİR.



KEP CAP

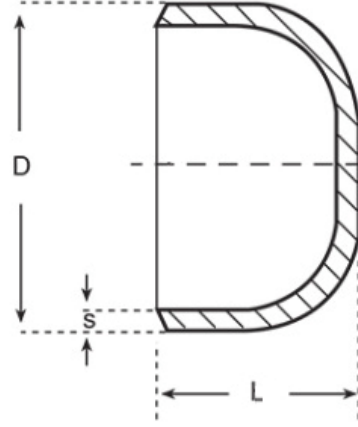

MADE IN TURKEY



KOD	İNÇ	DN	ÜRÜN ÖZ.	D	L	AGIRLIK (Kg)	KALINLIK (S)	FİYAT
TKK001	1 1/2"	DN 40	SCH20	48,26	2,5 CM	0,15	2,5 MM	₺30,50
TKK002	2"	DN 50	SCH20	60,3	2,5 CM	0,17	2,5 MM	₺33,50
TKK003	2 1/2"	DN 65	SCH20	73,03	2,5 CM	0,2	3 MM	₺40,00
TKK004	3"	DN 80	SCH20	88,9	2,5 CM	0,25	3 MM	₺42,50
TKK005	4"	DN 100	SCH20	114,3	3 CM	0,35	3 MM	₺57,50
TKK006	5"	DN 125	SCH20	141,3	5 CM	0,65	3 MM	₺95,00
TKK007	6"	DN 150	SCH20	168,3	5,5 CM	1,25	4 MM	₺135,00
TKK008	8"	DN 200	SCH20	219,1	6,5 CM	1,95	4 MM	₺287,50
TKK009	10"	DN 250	SCH20	273	6,5 CM	2,7	4 MM	₺387,50
TKK010	12"	DN 300	SCH20	323,9	9 CM	3	4 MM	₺741,00
TKK011	14"	DN 350	SCH20	355,6	9 CM	5,3	4 MM	₺1.110,00
TKK012	16"	DN 400	SCH20	406,4	11,5 CM	6	4 MM	₺1.230,00
TKK013	18"	DN 450	SCH20	457,2	13,5 CM	8	4 MM	₺1.590,00
TKK014	20"	DN 500	SCH20	508	17 CM	10	4 MM	₺1.785,00
TKK015	22"	DN 550	SCH20	558,8	20 CM	13	4 MM	₺2.520,00
TKK016	24"	DN 600	SCH20	609,5	23 CM	15	4 MM	₺3.150,00

* ÜRÜNLERİMİZ - + %5 DEĞİŞKENLİK GÖSTEREBİLİR.



sertifikalar

certificates

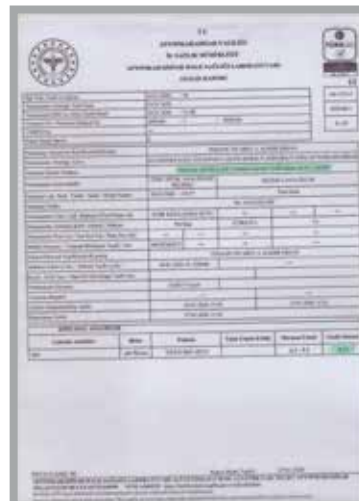



TEKSAN®

ISI & DOĞALGAZ MÜHENDİSLİK



Merkez Ofis (Head Office)

İstasyon Caddesi No:29 Bolvadin/Afyonkarahisar

Fabrika (Factory)

Selçuklu Mahallesi Ticaret Bölgesi No:316

Bolvadin/Afyonkarahisar

Afyonkarahisar Şube (Branch)

Karaman Mh. Alparslan Türkeş Cd. Hisar Apt. No:2/A

Afyonkarahisar

Tel.:0 272 612 43 87 Fax: 0 272 612 63 80

web: www.teksanisi.com e-mail: info@teksanisi.com