

# KAS®

*Evimizin her yerindeyiz!*



**Pirinç Vana &  
Parçaları**



**Armatür  
Grubu**

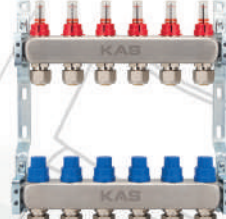

**Yerden Isıtma  
Sistemleri**



**Flex  
Grubu**

2024-01

**Fiyat Listesi**

Dünya'da 100'den fazla ülkede,  
aynı statüye sahip firmalarla

**"Uluslararası Güvenli Ticaret Ağı"**

oluşturmamıza imkan sağlayacak,

**Yetkilendirilmiş Yükümlü Sertifikamızı Aldık.**

TÜRKİYE CUMHURİYETİ  
TİCARET BAKANLIĞI



**Yetkilendirilmiş Yükümlü Sertifikası**  
**Kayalar Pres Döküm San. Tic. Ltd. Şti.**

Bu belge, 4458 sayılı Gümrük Kanununun 5/A maddesine  
istinaden yukarıda unvanı kayıtlı kişi adına,  
yetkilendirilmiş yükümlü statüsünün sağladığı hak ve  
kolaylıklardan yararlandırılmak üzere düzenlenmiştir.

Sertifika No: TR/AEO7/20340026



Ad Soyad *Yalçın Özdemir*  
Unvan *İstanbul Gümrük ve Dış Ticaret  
Bölge Müdürü*

**KAS**





**Sizlere sunduğumuz kaliteden  
hiçbir zaman ödün vermeyiz.**

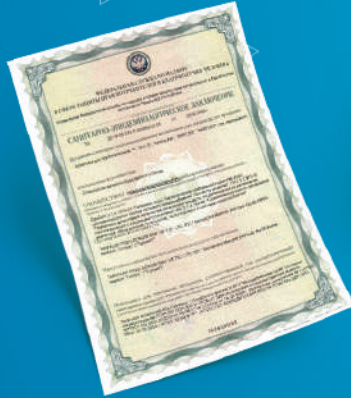
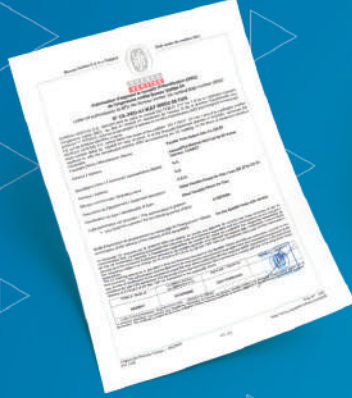

# Kayalar Grup

Kayalar Grup, bir aile şirketi olarak üretim faaliyetlerine 1970 yılında İstanbul'da üç kardeş tarafından başlamış, 1984 yılında kurulan Kayalar Pres Ltd. Şti. adı altında, piringten mamül parça ve fittingsler ile üretime devam ederek 1994 yılında KAS markasını tescil ettirmiştir. Böylece radyatör vanası ve piring fittingsler başta olmak üzere, sıhhi tesisat ve ısıtma tesisatları için yapmış olduğu ürün üretimini KAS markası ile piyasaya sunmaya başlamıştır. İstanbul Sancaktepe, Tuzla Deri OSB. ve Dilovası Makine İhtisas OSB. de bulunan toplam 50.000 m<sup>2</sup> kapalı alana sahip üretim tesislerinde ürün çeşidini ve üretim kapasitesini her geçen gün arttırmıştır.

Pazarlama ve satış faaliyetlerinin ayrı bir organizasyon altında yapılabilmesi amacıyla da 2000 yılında KASPA DIŞ TİC. A.Ş. grubun bünyesinde faaliyetlerine başlamıştır. Kayalar Grup, büyüme stratejisi doğrultusunda paslanmaz flex hortum imalatına başlanmış ve bu amaçla 2004 yılında Kayalar Armatür A.Ş. şirketini kurmuştur. 2009 yılında plastik boru ve ek parçaları üretimi, 2010 yılında da musluk ve su armatürleri üretimini gruba dahil edilmiştir. Üretim faaliyetlerindeki 50. yılında Kayalar Grup, bünyesinde bulunan 4 şirketi, 3 farklı üretim tesisi, konusunda bilgili ve deneyimli üretim, satış ve pazarlama ekipleri ile sektörün en köklü kuruluşlarından birisi halini almıştır.

Alanında birçok yeniliğe öncülük eden Kayalar Grup 50. yılında 300'e yakın ürün grubunda 1000'i aşkın ürün çeşidi ile müşterilerine hizmet vermektedir. Sektöründe doğalgaz, içme suyu, yangın tesisatları ile inşaat sektöründe, konut ve sanayide yer alan sıvı ve gaz akışkan tesisatlarında kullanılan birçok teknik ürünü müşterilerine sunan Kayalar Grup, kaliteyi müşterisinin en temel hakkı olarak görmektedir. TSE, TS EN, CEN, TSEK, GHOST, CE, Kiwa, SEPRO, ISO 9001, ISO 27001 gibi Sistem ve ürün kalite belgeleri ile hem üretim ve yönetim sistemlerinin, hem de ürettiği ürünlerin kalitesini güvence altında tutmaktadır. Toplam kalite yönetimi, stratejik yönetim ve değişim yönetimi tekniklerini aktif olarak uygulayarak günün koşullarına uygun ürün ve hizmetler geliştirmektedir. Üretim teknolojileri alanında çağın ve sektörün gelişmelerini takip ederek en üst teknoloji ile üretim yapmak amacıyla üretim teknolojileri alanında ciddi yatırımlara imza atan Kayalar Grup, bunun bir neticesi olarak KAS markasını sektörün verimlilik liderliği, maliyet liderliği ve inovasyon liderliğinde ilk





sıralarda yer alan bir marka haline getirmiştir. KAS Ar-Ge departmanının üretim teknikleri, ürünlere getirdiği inovatif yaklaşımı ve sahip olunan birçok patentli buluş ile KAS ürünleri, sektörde kalitesi, güvenilirliği, ergonomisi ve kullanım kolaylığı ile rakiplerinden fark edilen ürünler olarak görülmektedir. Katılımcı yönetim anlayışı ile süreçlerini sürekli iyileştiren, bilimsel yöntem ve sorun çözme teknikleri ile değişim ve iyileştirme süreçlerini yöneten, takım çalışmaları ile etkin ve verimli bir üretim ortamı oluşturan Kayalar Grup, sektördeki liderliğini pekiştirmektedir. Ürün ve hizmetlerini müşteri odaklı gerçekleştirmeyi iş hayatının olmazsa olmaz unsurlarından gören Kayalar Grup, pazarlama ve müşteri hizmetleri konusunda da geliştirdiği yaklaşımları ve müşteri anlayışı sayesinde sektörün en beğenilen kuruluşlarından birisi olmuştur.

KASPA DIŞ TİC. A.Ş. bünyesindeki pazarlama grubu, gerek iletişimin, gerek müşteri beklentileri konusundaki hassasiyetin, gerekse satış ve satış sonrası hizmet ve desteklerin geliştirilmesi konusunda yeni yaklaşımlar ve hizmetler üretmek üzere çalışan uzman ekibi ile sektörde müşterisine en hızlı ve en doğru hizmeti sunmayı amaçlamış, yaptığı eğitim ve bilgilendirme faaliyetleri ile sektörün büyümesine ve gelişmesine önemli destek sağlamıştır. Sadece üretim hayatında değil sosyal hizmet anlayışı ile de Kayalar Grup sektördeki benzeri kuruluşlardan ayrıcalıklı bir yapıya kavuşmuştur. Özellikle genç nesillerin eğitimi ve doğru bilgilendirilmesi amacıyla mesleki eğitimleri veren kurum ve kuruluşlar ile yakın diyalog içerisinde bulunmakta ve desteklemektedir. Bu kapsamda KAS AKADEMİ'yi kurarak çok sayıda öğrenciye destek vermekte ve özellikle metal endüstrisinde eğitim veren teknik liseler başta olmak üzere eğitim kurumlarımıza desteklerini sürdürmektedir. Ülkemizin adını yurt dışında da başarı ile temsil eden Kayalar Grup, yurt içinde edindiği tecrübe, kalite yaklaşımı ve müşteri odaklı pazarlama süreçlerinin tüm birikimleri ile ihracat faaliyetlerinde kısa sürede büyük bir ivme yakalamış ve komşu ülkeler başta olmak üzere onlarca ülkeye gerçekleştirdiği ihracatı ile adını ülkemiz sınırları dışına taşımıştır. Gelecek vizyonunda KAS markasını bir dünya markası haline getirmek yatan Kayalar Grup bu bağlamda belirlediği stratejik hedefleri doğrultusunda müşterilerinin de desteği ile yeni ve inovatif ürünleri ve müşteri hizmetleri ile geleceğin büyüyen gücü olmaya devam etmektedir.

# ► İÇİNDEKİLER



► Su ve Doğalgaz  
Tesisat Ürünleri

08



► Kas Therm  
Isı Çözümleri

24



► Flex Grubu

34



► Kastak Grubu

42



► Armatür

48



► Ankastr Ürünler

96



► Duş Setleri

110



► Yedek Parça

112



## ► Armatür ve Duş Setleri

Antoryum

50



Calista Gold

58



Calista

60



Lilyum

62



Fione Colored

64



Fione

66



Arnika

68



Zirkonyum

72



Çanak

74



Mutfak

77



Endüstriyel

86



Fotoselli

88



Musluk

91



Taharet  
Musluğu

94



Ankastre

96



Duş Setleri

104



Yedek Parça

112





# SU VE DOĐALGAZ TESİSAT ÜRÜNLERİ



Tüketici dostu çözümlerimizin en yenisi  
**KAS TASARRUF AİLESİ**

Yaşam alanınızı istediğiniz ısı seviyesinde tutar,  
ihtiyaç fazlası ısınma ve tüketimin önüne geçerek

***%30'a varan  
tasarruf sağlar***



## ► SU VE DOĞALGAZ TESİSAT ÜRÜNLERİ



**TS EN 331**

### ► Gaz Küresel Vana - Mop 5

KOD	AÇIKLAMA	K. AD.	B. FİYATI
07.04.830	1/2"	100	106,50 TL
07.04.831	3/4"	80	158,10 TL
07.04.402	1"	40	280,00 TL
07.04.403	1 1/4"	20	475,00 TL
07.04.404	1 1/2"	12	712,00 TL
07.04.405	2"	8	1.052,00 TL



**TS EN 331**

### ► Gaz Küresel Vana - Kilitli - Mop 5

KOD	AÇIKLAMA	K. AD.	B. FİYATI
07.05.830	1/2"	100	112,80 TL
07.05.831	3/4"	80	168,20 TL
07.05.402	1"	40	301,00 TL
07.03.801	3/4" - 1/2"	80	199,00 TL



**TS EN 331**

### ► Gaz Küresel Vana - Mop 0,5

KOD	AÇIKLAMA	K. AD.	B. FİYATI
07.07.400	1/2"	100	135,70 TL
07.07.401	3/4"	80	201,00 TL
07.07.402	1"	40	356,00 TL
07.07.403	1 1/4"	20	606,00 TL
07.07.404	1 1/2"	12	910,00 TL
07.07.405	2"	8	1.343 ,00 TL



## ► SU VE DOĞALGAZ TESİSAT ÜRÜNLERİ



**TS EN 13828**

### ► Su Küresel Vana - İçme Suyu (PN 10)

KOD	AÇIKLAMA	K. AD.	B. FİYATI
08.01.430	1/2"	100	126,10 TL
08.01.431	3/4"	80	191,60 TL
08.01.432	1"	40	316,00 TL
08.01.433	1 1/4"	20	589,00 TL
08.01.434	1 1/2"	12	765,00 TL
08.01.435	2"	8	1.179,00 TL



**TS EN 13547**

### ► Su Küresel Vana - Endüstriyel (PN 40)

KOD	AÇIKLAMA	K. AD.	B. FİYATI
08.02.430	1/2"	100	146,30 TL
08.02.431	3/4"	80	177,30 TL
08.02.432	1"	40	327,00 TL
08.02.433	1 1/4"	20	516,00 TL
08.02.434	1 1/2"	12	776,00 TL
08.02.435	2"	8	1.203,00 TL



### ► Su Küresel Vana (PN 40)

KOD	AÇIKLAMA	K. AD.	B. FİYATI
08.09.530	1/2"	100	112,10 TL
08.09.531	3/4"	80	162,00 TL
08.09.452	1"	40	263,00 TL



### ► Su Küresel Vana (PN 16)

KOD	AÇIKLAMA	K. AD.	B. FİYATI
80.61.426	2 1/2"	4	4.047,00 TL
80.61.427	3"	3	5.869,00 TL
80.61.428	4"	2	10.111,00 TL

## ► SU VE DOĞALGAZ TESİSAT ÜRÜNLERİ



### ► Su Küresel Vana (PN 40)

KOD	AÇIKLAMA	K. AD.	B. FİYATI
08.09.528	1/4"	120	116,90 TL
08.09.529	3/8"	120	112,30 TL



### TS EN 13547 ► Su Küresel Vana - Endüstriyel (PN 25)

KOD	AÇIKLAMA	K. AD.	B. FİYATI
08.09.430	1/2"	100	147,50 TL
08.09.431	3/4"	80	177,30 TL
08.09.432	1"	40	318,00 TL
08.09.433	1 1/4"	20	489,00 TL
08.09.434	1 1/2"	12	770,00 TL
08.09.435	2"	8	1.195,00 TL



### ► Rakorlu Su Küresel Vana Kelebek Kollu

KOD	AÇIKLAMA	K. AD.	B. FİYATI
08.05.530	1/2"	60	198,30 TL
08.05.531	3/4"	50	293,00 TL
08.08.327	1"	40	359,00 TL
08.05.329	1 1/4"	20	634,00 TL



### ► Rakorlu Su Küresel Vana Sensör Kovanlı

KOD	AÇIKLAMA	K. AD.	B. FİYATI
08.07.452	1" SENSÖR KOVANLI	40	335,00 TL

## ► SU VE DOĞALGAZ TESİSAT ÜRÜNLERİ



### ► Su Küresel Vana - Kelebek Kollu (PN 25)

KOD	AÇIKLAMA	K. AD.	B. FİYATI
08.03.430	1/2" Dış Dişli	100	151,20 TL
08.03.431	3/4" Dış Dişli	80	204,00 TL
08.03.432	1" Dış Dişli	40	323,00 TL
08.04.430	1/2" İç Dişli	100	149,70 TL
08.04.431	3/4" İç Dişli	80	190,20 TL
08.04.432	1" İç Dişli	40	322,00 TL

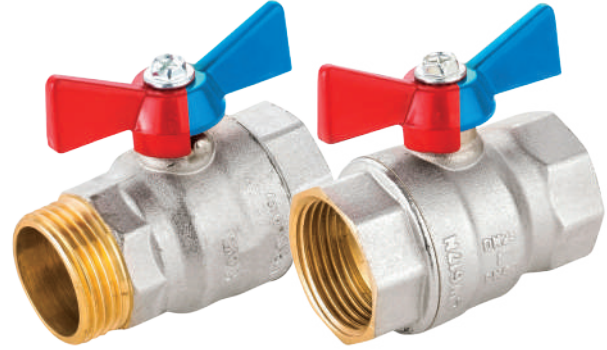

### ► Su Küresel Vana - Kelebek Kollu (PN 40)

KOD	AÇIKLAMA	K. AD.	B. FİYATI
08.03.530	1/2" Dış Dişli	100	124,40 TL
08.03.531	3/4" Dış Dişli	80	175,40 TL
08.03.532	1" Dış Dişli	40	296,00 TL
08.04.530	1/2" İç Dişli	100	125,60 TL
08.04.531	3/4" İç Dişli	80	179,90 TL
08.04.532	1" İç Dişli	40	294,00 TL



yeni  
ürün

### ► Köşe Rakorlu Küresel Vana Termometreli

KOD	AÇIKLAMA	K. AD.	B. FİYATI
08.07.552	1"		647,00 TL



### ► Filtreli Küresel Vana

KOD	AÇIKLAMA	K. AD.	B. FİYATI
08.08.448	1/2"	60	284,00 TL
08.08.449	3/4"	50	382,00 TL



## ► SU VE DOĞALGAZ TESİSAT ÜRÜNLERİ



### ► Dişli - PPRC Bağlantılı Küresel Vana

KOD	AÇIKLAMA	K. AD.	B. FİYATI
08.08.730	3/4" Dişli - DN20 PPRC Bağlantılı	50	308,00 TL
08.08.731	1" Dişli - DN25 PPRC Bağlantılı	40	402,00 TL
08.08.732	1 1/4" Dişli - DN32 PPRC Bağlantılı	30	544,00 TL



### ► PPRC Bağlantılı Küresel Vana

KOD	AÇIKLAMA	K. AD.	B. FİYATI
08.09.730	DN20 - DN20 PPRC Bağlantılı	50	254,00 TL
08.09.731	DN25 - DN25 PPRC Bağlantılı	40	353,00 TL
08.09.732	DN32 - DN32 PPRC Bağlantılı	30	481,00 TL

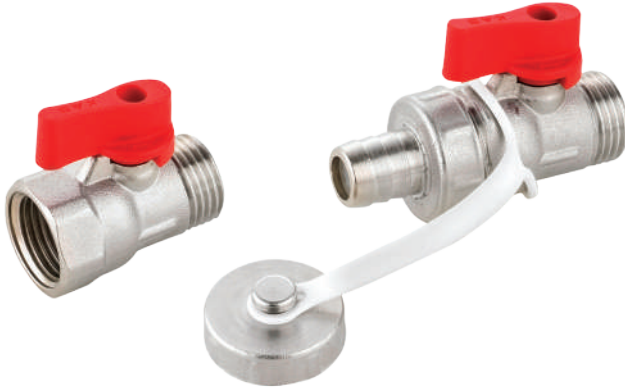

### ► Mini Küresel Vana

KOD	AÇIKLAMA	K. AD.	B. FİYATI
05.03.320	1/4"	250	94,05 TL
05.03.321	3/8"	250	87,58 TL
05.03.322	1/2"	200	96,29 TL
05.03.323	3/4"	120	138,30 TL
05.04.322	1/2" Boşaltma Vanası	200	182,10 TL



### ► Kartuşlu Basınç Düşürücü



KOD	AÇIKLAMA	K. AD.	B. FİYATI
71.07.620	1/2"		602,00 TL
71.07.621	3/4"		615,00 TL
71.07.622	1"		713,00 TL

# KAS®

## KARTUŞLU BASINÇ DÜŞÜRÜCÜ

Ergonomik tasarımı sayesinde kolay ve hassas ayar özelliği.

Kavitasyon etkisine, oksit ve korozif etmenlerin oluşumuna karşı dirençlidir.

Mühendislik tasarımı ve ergonomik manometre bağlantısı sayesinde kısıtlı alanlarda rahatça kullanılır.

İçerisindeki filtre yabancı maddeleri engelleyerek ürünün ve tesisatın diğer bileşenlerinin sağlıklı çalışmasını sağlar.



Yüksek basınçtan dolayı tesisat sistemlerinde oluşabilecek tahribatı önler.

Uzun kullanım süresine sahiptir.

● **71.07.620** - 1/2"

● **71.07.621** - 3/4"

● **71.07.622** - 1"

[www.kas.com.tr](http://www.kas.com.tr)

## ► SU VE DOĞALGAZ TESİSAT ÜRÜNLERİ



### ► Köşe Termostatik Radyatör Vanası (Jaklı)

KOD	AÇIKLAMA	K. AD.	B. FİYATI
13.50.001	1/2"	30	350,00 TL
13.50.002	1/2" - 16x2 Pex-B Bağlantılı	30	382,00 TL



### ► Kablosuz Dijital Termostatik Başlık

KOD	AÇIKLAMA	K. AD.	B. FİYATI
20.07.501	Kablosuz Dijital Başlık		1.441,00 TL
20.07.601	Ağ Geçidi Modülü		1.549,00 TL



### ► Kompakt Ventil Termostatik Vana

KOD	AÇIKLAMA	K. AD.	B. FİYATI
23.60.051	Kompakt Ventil	30	415,00 TL
23.60.053	Kompakt Ventil (Alüminyum Radyatör İçin)	30	566,00 TL
23.60.054	Kompakt Ventil	30	516,00 TL
23.60.055	Kompakt Ventil	30	526,00 TL

\* 15°C Sabitleme yapılabilir. Termostatik kafa fiyata dahildir.



### ► Düz Termostatik Vana

KOD	AÇIKLAMA	K. AD.	B. FİYATI
13.40.009	1/2"	30	474,00 TL

\* 15°C Sabitleme yapılabilir.



## ► SU VE DOĞALGAZ TESİSAT ÜRÜNLERİ



### ► Aksel Termostatik Vana

KOD	AÇIKLAMA	K. AD.	B. FİYATI
13.40.007	1/2"	30	522,00 TL

\* 15°C Sabitleme yapılabilir.

### ► Aksel Termostatik Vana

KOD	AÇIKLAMA	K. AD.	B. FİYATI
13.40.008	1/2" Boru Bağlantılı	30	537,00 TL
13.40.006	1/2" Pex Bağlantılı	30	552,00 TL

\* 15°C Sabitleme yapılabilir.

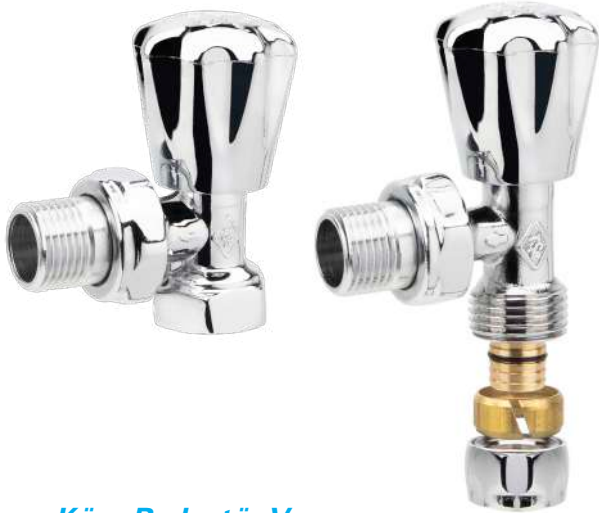

### ► Köşe Radyatör Vanası

KOD	AÇIKLAMA	K. AD.	B. FİYATI
04.07.307	1/2"	50	212,00 TL
04.07.309	1/2" - 16x2 Pex-B Bağlantılı	50	244,00 TL



### ► Köşe Radyatör Vanası

KOD	AÇIKLAMA	K. AD.	B. FİYATI
04.11.307	1/2"	50	277,00 TL
04.11.309	1/2" - 16x2 Pex-B Bağlantılı	50	309,00 TL

## ► SU VE DOĞALGAZ TESİSAT ÜRÜNLERİ



### ► Köşe Rakorlu Vana (Tip6)

KOD	AÇIKLAMA	K. AD.	B. FİYATI
04.14.307-01	1/2"	50	116,00 TL
04.14.309-01	1/2" - 16x2 Pex-B Bağlantılı	50	145,00 TL

(\*) Yapı malzemelerinin tabi olacağı kriterler hakkında yönetmelik kapsamındaki yapılarda kullanılmaz.



### ► Köşe Radyatör Vanası (Tip4)

KOD	AÇIKLAMA	K. AD.	B. FİYATI
04.01.307	1/2"	50	131,40 TL
04.01.309	1/2" - 16x2 Pex-B Bağlantılı	50	141,10 TL



### ► Köşe Radyatör Vana (Tip6)

KOD	AÇIKLAMA	K. AD.	B. FİYATI
04.14.307	1/2"	50	111,80 TL
04.14.309	1/2" - 16x2 Pex-B Bağlantılı	50	140,20 TL

(\*) Yapı malzemelerinin tabi olacağı kriterler hakkında yönetmelik kapsamındaki yapılarda kullanılmaz.



### ► Köşe Radyatör Vanası (Tip3)

KOD	AÇIKLAMA	K. AD.	B. FİYATI
04.01.303	1/2"	50	160,10 TL
04.01.308	1/2" - 16x2 Pex-B Bağlantılı	50	184,60 TL
04.05.310	3/4"	50	214,00 TL

## ► SU VE DOĞALGAZ TESİSAT ÜRÜNLERİ



### ► Köşe Radyatör Vanası (Tip3)

KOD	AÇIKLAMA	K. AD.	B. FİYATI
04.01.304	1/2" - 16x2 Boru Bağlantılı	50	173,40 TL



### ► Düz Radyatör Vanası (Tip3)

KOD	AÇIKLAMA	K. AD.	B. FİYATI
04.02.301	1/2"	50	182,80 TL
04.04.301	1/2" - 16x2 Pex-B Bağlantılı	50	246,00 TL
04.05.311	3/4"	50	245,00 TL



### ► Köşe Geri Dönüş Vanası (Tip3)

KOD	AÇIKLAMA	K. AD.	B. FİYATI
04.04.309	1/2" - 16x2 Pex-B Bağlantılı	100	166,60 TL
04.04.305	1/2" G.D. Rakorlu Vana	50	126,50 TL

(\*) Yapı malzemelerinin tabi olacağı kriterler hakkında yönetmelik kapsamındaki yapılarda kullanılmaz.



### ► Düz - Köşe Rakor

KOD	AÇIKLAMA	K. AD.	B. FİYATI
03.01.250	1/2" Düz	150	97,35 TL
03.01.251	3/4" Düz	90	144,10 TL
03.01.252	1" Düz	50	219,00 TL
03.01.253	1 1/4" Düz	48	377,00 TL
03.01.254	1 1/2" Düz	36	569,00 TL
03.01.255	2" Düz	20	921,00 TL
03.02.260	1/2" Köşe	150	117,90 TL
03.02.261	3/4" Köşe	100	176,40 TL
03.02.262	1" Köşe	50	289,00 TL
03.02.263	1 1/4" Köşe	12	483,00 TL
03.02.264	1 1/2" Köşe	20	751,00 TL
03.02.265	2" Köşe	12	1.249,00 TL



## ► SU VE DOĞALGAZ TESİSAT ÜRÜNLERİ



### ► Filtreli Musluk (PN 10)

KOD	AÇIKLAMA	K. AD.	B. FİYATI
01.07.179	1/2" - 3/8" Taharat Musl.	160	101,10 TL
01.06.173	Çamaşır - Bulaşık Mak. Mus.	100	167,50 TL
01.05.173	Çamaşır - Bulaşık Mak. Mus. (Kumlu)	100	135,20 TL
01.07.179-01	1/2" - 3/8" Taharat Musl. (Aynalı)	120	107,50 TL
01.06.173-01	Çamaşır - Bulaşık Mak. Mus. (Aynalı)	100	173,30 TL
01.05.173-01	Çamaşır - Bulaşık Mak. Mus. (Kumlu) (Aynalı)	100	141,10 TL
01.03.171	Taharet Musluk Aynası	600	8,60 TL



### ► Bahçe Küresel (PN 10) Pirinç Rakorlu

KOD	AÇIKLAMA	K. AD.	B. FİYATI
09.06.921	1/2" Tek Parça Rakorlu	50	195,60 TL
09.03.922	3/4" Rakor 3/4" Bağlantı	50	231,00 TL



### ► Küresel Bas (PN 10)

KOD	AÇIKLAMA	K. AD.	B. FİYATI
10.01.370	3/4"	50	228,00 TL
10.01.371	3/4" Paslanmaz Kol*	50	268,00 TL
10.01.372	3/4" - 3/4" Bağlantılı	50	253,00 TL

(\*) Kol ve somun nemli ortamlarda kullanıma uygun paslanmaz çelikten (AISI 304) imal edilmiştir.

Talep edildiği takdirde kelebek kollu olarak imal edilebilir.



### ► Bahçe Küresel (PN 10) Pirinç Rakorlu Kelebek Kol

KOD	AÇIKLAMA	K. AD.	B. FİYATI
09.07.921	1/2" Tek Parça Rakorlu	50	195,50 TL
09.04.922	3/4" Rakor 3/4" Bağ.	50	231,00 TL

## ► SU VE DOĞALGAZ TESİSAT ÜRÜNLERİ



### ► Çalparalı (Yatay) Çekvalf

KOD	AÇIKLAMA	K. AD.	B. FİYATI
80.82.460	1/2"	100	163,80 TL
80.82.461	3/4"	75	204,00 TL
80.82.462	1"	50	306,00 TL
80.82.463	1 1/4"	50	511,00 TL
80.82.464	1 1/2"	40	660,00 TL
80.82.465	2"	15	889,00 TL
80.82.466	2 1/2"	10	1.693,00 TL
80.82.467	3"	6	2.140,00 TL



### ► Yaylı (Dik) Çekvalf - Sessiz

KOD	AÇIKLAMA	K. AD.	B. FİYATI
80.81.470	1/2"	100	132,50 TL
80.81.471	3/4"	75	195,20 TL
80.81.472	1"	50	261,00 TL
80.81.473	1 1/4"	50	426,00 TL
80.81.474	1 1/2"	40	592,00 TL
80.81.475	2"	24	797,00 TL
80.81.476	2 1/2"	12	2.121,00 TL
80.81.477	3"	6	2.793,00 TL



### ► Doğalgaz Macunu

KOD	AÇIKLAMA	K. AD.	B. FİYATI
70.03.800	Doğalgaz Tesisat Macunu	24	77,92 TL



### ► Flatör - Paslanmaz Mühreli

KOD	AÇIKLAMA	K. AD.	B. FİYATI
80.71.540	1/2"	50	189,30 TL
80.71.541	3/4"	50	230,00 TL
80.71.542	1"	50	280,00 TL
80.71.543	1 1/4"	20	781,00 TL
80.71.544	1 1/2"	20	873,00 TL
80.71.545	2"	20	1.009,00 TL

## ► SU VE DOĞALGAZ TESİSAT ÜRÜNLERİ



### ► Filtre (Pislik Tutucu)

KOD	AÇIKLAMA	K. AD.	B. FİYATI
12.02.340	1/2"	150	87,50 TL
12.02.341	3/4"	80	144,40 TL
12.02.342	1"	50	260,00 TL
80.31.343	1 1/4"	30	470,00 TL
80.31.344	1 1/2"	20	554,00 TL
80.31.345	2"	10	956,00 TL
80.31.346	2" 1/2"	8	1.683,00 TL
80.31.347	3"	6	2.387,00 TL
80.31.348	4"	4	4.874,00 TL

### ► Uzatma Grubu

KOD	AÇIKLAMA	K. AD.	B. FİYATI
80.04.160	1/2" - 3/4" Bas Uzatma	250	58,87 TL
80.04.175	3/4" Düz Armatür Uzatması	100	71,00 TL
80.04.176	3/4" Delikli Armatür Uza.	100	111,20 TL
80.04.180	1/2" Bulaşık Makinası Uza.	100	93,68 TL
80.04.185	3/4" Çamaşır Musluk Çatalı	100	110,00 TL



### ► Uzatma (25 mm)

KOD	AÇIKLAMA	K. AD.	B. FİYATI
80.01.101	1/2" 1 cm	500	27,71 TL
80.01.102	1/2" 1,5 cm	400	31,64 TL
80.01.103	1/2" 2 cm	300	37,50 TL
80.01.104	1/2" 2,5 cm	250	43,83 TL
80.01.105	1/2" 3 cm	200	50,34 TL
80.01.106	1/2" 4 cm	175	76,37 TL
80.01.107	1/2" 5 cm	150	88,84 TL



### ► Şiber Vana

KOD	AÇIKLAMA	K. AD.	B. FİYATI
11.01.850	1/2"	60	210,00 TL
11.01.951	3/4"	50	186,70 TL
11.01.852	1"	30	372,00 TL



## ► SU VE DOĞALGAZ TESİSAT ÜRÜNLERİ



### ► Rakorlar

KOD	AÇIKLAMA	K. AD.	B. FİYATI
80.23.241	1/2"	500	38,62 TL
80.23.242	3/4"	300	52,39 TL
80.23.243	1"	150	84,62 TL
80.23.244	1 1/4"	100	112,60 TL
80.23.245	1 1/2"	75	202,00 TL
80.23.246	2"	40	356,00 TL
80.22.191	3/4" Su Saati Rakoru	100	85,10 TL

### ► Stop Vana

KOD	AÇIKLAMA	K. AD.	B. FİYATI
11.02.850	1/2"	60	299,00 TL
11.02.851	3/4"	40	224,00 TL
11.02.852	1"	30	597,00 TL



### ► Nipel

KOD	AÇIKLAMA	K. AD.	B. FİYATI
02.02.200	3/8"	500	18,54 TL
02.02.201	1/2"	250	32,84 TL
02.02.202	3/4"	200	64,00 TL
02.02.203	1"	100	92,00 TL

### ► Orantılı Nipel - Redüksiyon

KOD	AÇIKLAMA	K. AD.	B. FİYATI
02.03.210	3/8" - 1/2" Orantılı Nipel	300	40,76 TL
02.03.211	1/2" - 3/4" Orantılı Nipel	250	53,14 TL
02.03.212	3/4" - 1" Orantılı Nipel	100	79,37 TL
02.01.195	3/8" - 1/2" Redüksiyon	500	30,32 TL
02.01.196	1/2" - 3/4" Redüksiyon	300	39,84 TL

# ► KAS YERDEN ISITMA ÇÖZÜMLERİ



*Yıllara meydan okuyan yeni ürünümüz*

## ***Kompakt Karışım Devresi***

*AR-GE ekibimizin, kaliteden ödün vermeyen inovasyon anlayışı ile tasarladığı, yeni bir teknoloji ile ürettiğimiz ürünümüzle işinizi kolaylaştırmaya devam ediyoruz.*

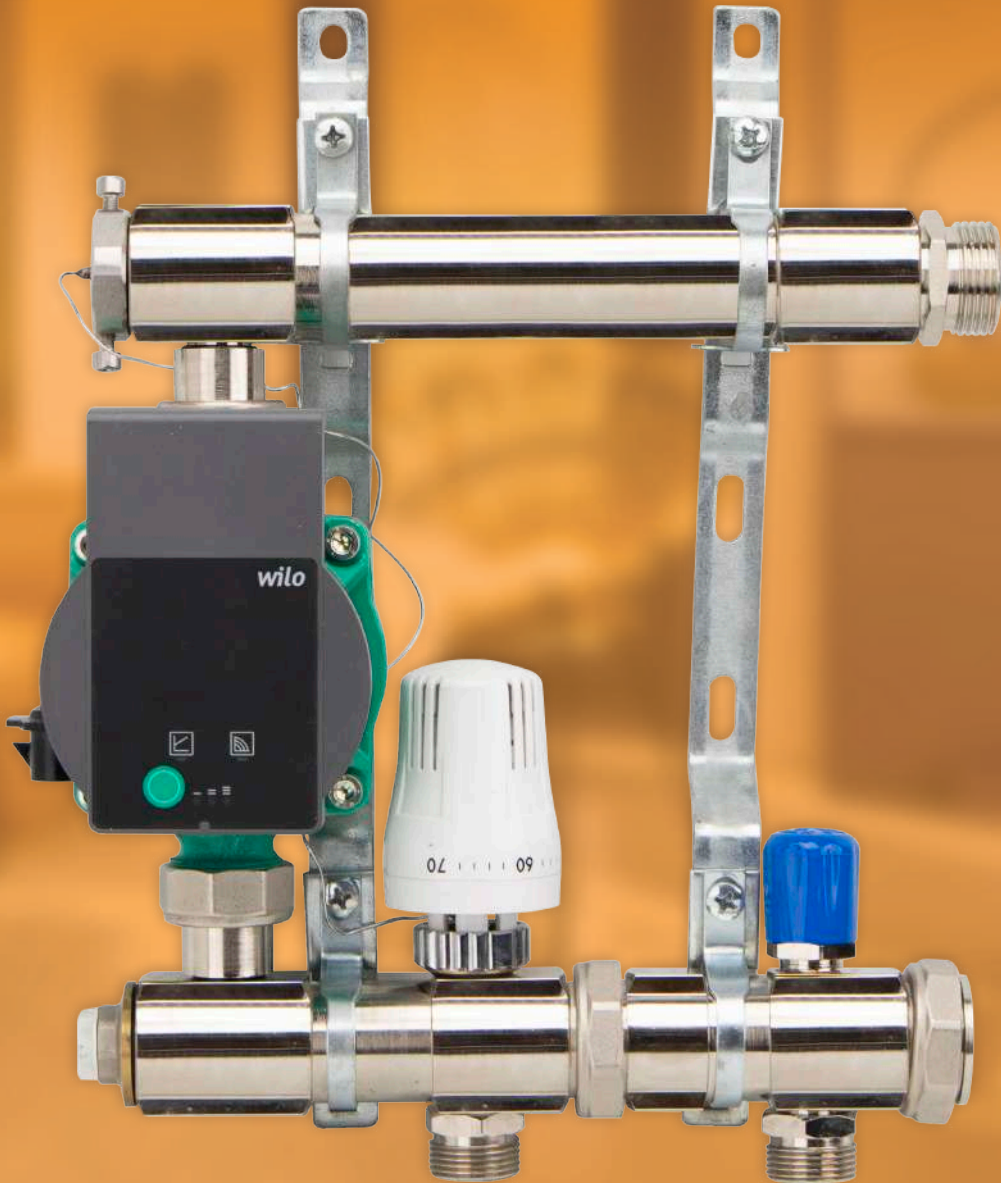

## ► KAS YERDEN ISITMA SİSTEMLERİ

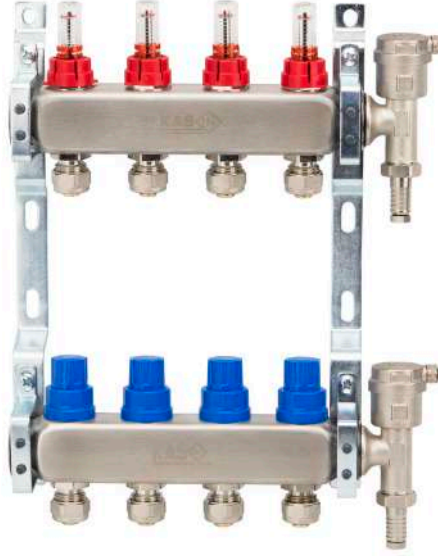

### ► Kare Tip Set - Debili - Termostat Set

KOD	AÇIKLAMA	K. AD.	B. FİYATI
18.22.902	2 Delikli	1	2.733,00 TL
18.22.903	3 Delikli	1	3.400,00 TL
18.22.904	4 Delikli	1	4.062,00 TL
18.22.905	5 Delikli	1	4.701,00 TL
18.22.906	6 Delikli	1	5.376,00 TL
18.22.907	7 Delikli	1	5.996,00 TL
18.22.908	8 Delikli	1	6.693,00 TL
18.22.909	9 Delikli	1	7.326,00 TL
18.22.910	10 Delikli	1	7.955,00 TL
18.22.911	11 Delikli	1	8.604,00 TL
18.22.912	12 Delikli	1	9.251,00 TL

**Kutu İçeriği:** 1 Adet Debili Kollektör, 1 Adet Termostatik Salmastralı Kollektör, 2 Adet Tahliye Vanası, 2 Adet Kelepçe



### ► Kompakt Karışım Devresi

KOD	AÇIKLAMA	K. AD.	B. FİYATI
20.01.001	-	1	5.209,00 TL

**Kutu İçeriğine Sirkülasyon pompası dahil değildir.**



**yeni ürün**

### ► Bypasslı Kompakt Karışım Devresi

KOD	AÇIKLAMA	K. AD.	B. FİYATI
20.01.003	-	1	12.189,00 TL



## ► KAS YERDEN ISITMA SİSTEMLERİ



### ► Kare Tip Debili Kollektör

KOD	AÇIKLAMA	K. AD.	B. FİYATI
18.31.902	2 Delikli	8	907,00 TL
18.31.903	3 Delikli	8	1.235,00 TL
18.31.904	4 Delikli	4	1.617,00 TL
18.31.905	5 Delikli	4	1.984,00 TL
18.31.906	6 Delikli	4	2.346,00 TL
18.31.907	7 Delikli	4	2.716,00 TL
18.31.908	8 Delikli	4	3.083,00 TL
18.31.909	9 Delikli	4	3.449,00 TL
18.31.910	10 Delikli	4	3.815,00 TL
18.31.911	11 Delikli	4	4.254,00 TL
18.31.912	12 Delikli	2	4.615,00 TL

Not: 18.09.345 kodlu plastik purjörli kollektör tapası ayrıca satılır.

### ► Kare Tip Termostatik Kollektör

KOD	AÇIKLAMA	K. AD.	B. FİYATI
18.32.902	2 Delikli	8	906,00 TL
18.32.903	3 Delikli	8	1.312,00 TL
18.32.904	4 Delikli	4	1.720,00 TL
18.32.905	5 Delikli	4	2.112,00 TL
18.32.906	6 Delikli	4	2.500,00 TL
18.32.907	7 Delikli	4	2.896,00 TL
18.32.908	8 Delikli	4	3.288,00 TL
18.32.909	9 Delikli	4	3.682,00 TL
18.32.910	10 Delikli	4	4.061,00 TL
18.32.911	11 Delikli	4	4.521,00 TL
18.32.912	12 Delikli	3	4.923,00 TL

Not: 18.09.345 kodlu plastik purjörli kollektör tapası ayrıca satılır.



### ► Kollektör Rakoru - Termometre Saatli

KOD	AÇIKLAMA	K. AD.	B. FİYATI
20.06.005	1" Termometreli	30	352,00 TL
20.06.006	1" Manometreli	30	381,00 TL



### ► Rakorlu Su Küresel Vana Sensör Kovanlı

KOD	AÇIKLAMA	K. AD.	B. FİYATI
08.15.327	1" Termometreli	20	606,00 TL
08.16.327	1" Manometreli	20	627,00 TL

## ► KAS YERDEN ISITMA SİSTEMLERİ



► **Çift Tarafli Bağlantı Vanası**

KOD	AÇIKLAMA	K. AD.	B. FİYATI
20.06.001	1"	50	331,00 TL



► **Aktüatör**

KOD	AÇIKLAMA	K. AD.	B. FİYATI
20.07.204	230 V NC, 2 WATT	40	708,00 TL



► **Wi-Fi Akıllı Kablolulu Oda Termostatı**

yeni ürün

KOD	AÇIKLAMA	K. AD.	B. FİYATI
20.07.306	230V +5°C +35°C Sıcaklık Aralığı	36	1.986,00 TL
20.07.307	DOKUNMATİK Tuş 230V +5°C +35°C Sıcaklık Aralığı	36	3.203,00 TL



► **2 Yollu Vana - 3 Yollu Vana**

KOD	AÇIKLAMA	K. AD.	B. FİYATI
20.06.002	1"	20	530,00 TL
20.06.003	1"	12	2.458,00 TL
20.05.002	1" MOTORLU	20	3.628,00 TL



► **Dijital - Analog Oda Termostatı**

KOD	AÇIKLAMA	K. AD.	B. FİYATI
20.07.304	Analog - 230 V / +5°C +30°C Sıcaklık Aralığı	36	987,00 TL
20.07.305	Dijital - 230 V / +5°C +30°C Sıcaklık Aralığı	36	1.480,00 TL

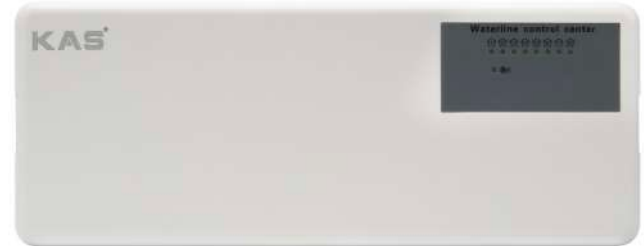

► **Dağıtıcı Terminal**

KOD	AÇIKLAMA	K. AD.	B. FİYATI
20.07.008	8 Zonlu Maks.	5	1.612,00 TL

## ► KAS YERDEN ISITMA SİSTEMLERİ



► **Kazan Emniyet Grubu**

KOD	AÇIKLAMA	K. AD.	B. FİYATI
80.60.710	1"	1	1.556,00 TL



► **Sirkülasyon Pompası**

KOD	AÇIKLAMA	K. AD.	B. FİYATI
20.07.101	-	1	11.669,00 TL



► **Boru Bağlantı Rakoru**

KOD	AÇIKLAMA	K. AD.	B. FİYATI
20.06.004	16x2	20	170,10 TL



► **Isı Sensör Kablosu**

KOD	AÇIKLAMA	K. AD.	B. FİYATI
20.07.401	-	50	132,60 TL



► **Termostatik Salmastralı Kollektör 1" 16x2 (PN 10)**

KOD	AÇIKLAMA	K. AD.	B. FİYATI
18.16.502	2 Delikli	30	960,00 TL
18.16.503	3 Delikli	20	1.376,00 TL
18.16.504	4 Delikli	20	1.789,00 TL
18.16.505	5 Delikli	20	2.208,00 TL
18.16.506	6 Delikli	10	2.615,00 TL
18.16.507	7 Delikli	10	3.028,00 TL
18.16.508	8 Delikli	10	3.455,00 TL
18.16.509	9 Delikli	10	3.864,00 TL
18.16.510	10 Delikli	10	4.286,00 TL
18.16.511	11 Delikli	5	4.707,00 TL
18.16.512	12 Delikli	10	5.153,00 TL
18.16.513	13 Delikli	5	5.600,00 TL

\*\* 17x2 Bağlantı İçin Fiyat Sorunuz



► **Debili Kontrollü Kollektör 1" 16x2 (PN 10)**

KOD	AÇIKLAMA	K. AD.	B. FİYATI
18.15.502	2 Delikli	20	912,00 TL
18.15.503	3 Delikli	10	1.304,00 TL
18.15.504	4 Delikli	10	1.693,00 TL
18.15.505	5 Delikli	10	2.089,00 TL
18.15.506	6 Delikli	5	2.472,00 TL
18.15.507	7 Delikli	5	2.861,00 TL
18.15.508	8 Delikli	5	3.265,00 TL
18.15.509	9 Delikli	5	3.649,00 TL
18.15.510	10 Delikli	5	4.048,00 TL
18.15.511	11 Delikli	5	4.445,00 TL
18.15.512	12 Delikli	5	4.867,00 TL
18.15.513	13 Delikli	5	5.290,00 TL

\*\* 17x2 Bağlantı İçin Fiyat Sorunuz

## ► KAS YERDEN ISITMA SİSTEMLERİ

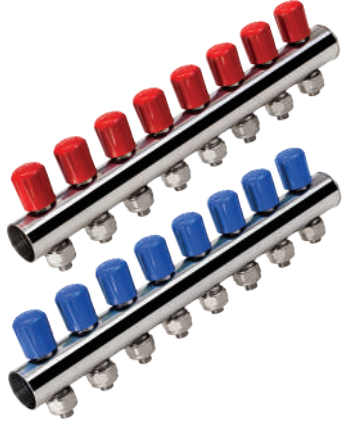

### ► Vanalı Kollektör - Paslanmaz Çelik 1"-16x2 (PN 10)

KOD	AÇIKLAMA	K. AD.	B. FİYATI
18.21.782	2 Delikli	30	401,00 TL
18.21.783	3 Delikli	20	537,00 TL
18.21.784	4 Delikli	20	672,00 TL
18.21.785	5 Delikli	20	807,00 TL
18.21.786	6 Delikli	10	944,00 TL
18.21.787	7 Delikli	10	1.078,00 TL
18.21.788	8 Delikli	10	1.214,00 TL
18.21.789	9 Delikli	10	1.349,00 TL
18.21.790	10 Delikli	10	1.484,00 TL
18.21.791	11 Delikli	10	1.606,00 TL
18.21.792	12 Delikli	10	1.729,00 TL
18.21.793	13 Delikli	10	1.850,00 TL

\*\* 17x2 Bağlantı İçin Fiyat Sorunuz

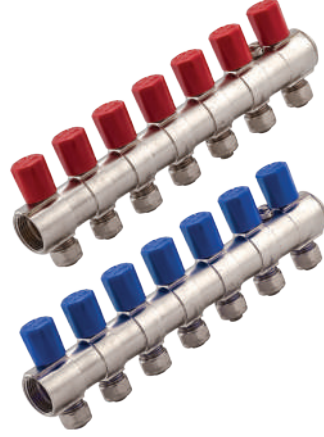

### ► Vanalı Kollektör - Pirinç 1"-16x2 (PN 10)

KOD	AÇIKLAMA	K. AD.	B. FİYATI
18.01.582	2 Delikli	30	443,00 TL
18.01.583	3 Delikli	20	625,00 TL
18.01.584	4 Delikli	20	806,00 TL
18.01.585	5 Delikli	20	988,00 TL
18.01.586	6 Delikli	10	1.167,00 TL
18.01.587	7 Delikli	10	1.344,00 TL
18.01.588	8 Delikli	10	1.528,00 TL
18.01.589	9 Delikli	10	1.719,00 TL
18.01.590	10 Delikli	10	1.868,00 TL
18.01.591	11 Delikli	10	2.113,00 TL
18.01.592	12 Delikli	10	2.325,00 TL
18.01.593	13 Delikli	10	2.504,00 TL

\*\* 17x2 Bağlantı İçin Fiyat Sorunuz

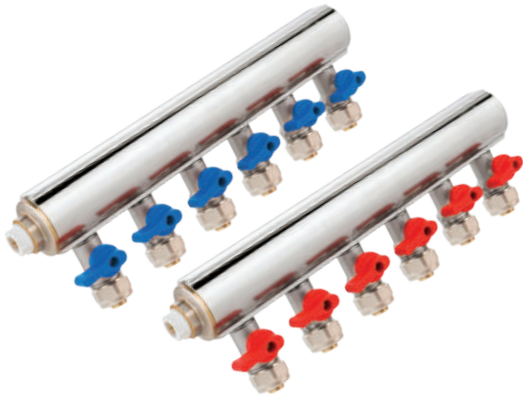

### ► 3/8 Mini Vanalı Kollektör - Pirinç 1"-16x2 (PN 10)

KOD	AÇIKLAMA	K. AD.	B. FİYATI
18.19.882	2 Delikli	16	556,00 TL
18.19.883	3 Delikli	16	795,00 TL
18.19.884	4 Delikli	16	1.035,00 TL
18.19.885	5 Delikli	8	1.277,00 TL
18.19.886	6 Delikli	8	1.516,00 TL
18.19.887	7 Delikli	8	1.750,00 TL
18.19.888	8 Delikli	8	1.998,00 TL
18.19.889	9 Delikli	8	2.200,00 TL
18.19.890	10 Delikli	8	2.433,00 TL
18.19.891	11 Delikli	8	2.696,00 TL
18.19.892	12 Delikli	8	2.933,00 TL
18.19.893	13 Delikli	8	3.183,00 TL

\*\* 17x2 Bağlantı İçin Fiyat Sorunuz

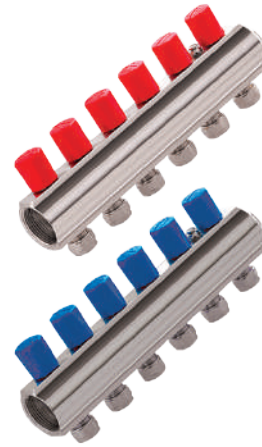

### ► Vanalı Kollektör - Pirinç 1 1/4"-16x2 (PN 10)

KOD	AÇIKLAMA	K. AD.	B. FİYATI
18.03.703	3 Delikli	16	1.019,00 TL
18.03.704	4 Delikli	16	1.315,00 TL
18.03.705	5 Delikli	16	1.612,00 TL
18.03.706	6 Delikli	8	1.925,00 TL
18.03.707	7 Delikli	8	2.200,00 TL
18.03.708	8 Delikli	8	2.495,00 TL
18.03.709	9 Delikli	8	2.785,00 TL
18.03.710	10 Delikli	8	3.108,00 TL
18.03.711	11 Delikli	8	3.445,00 TL
18.03.712	12 Delikli	8	3.738,00 TL
18.03.713	13 Delikli	8	4.033,00 TL

\*\* 17x2 Bağlantı İçin Fiyat Sorunuz



## ► KAS YERDEN ISITMA SİSTEMLERİ



### ► Tahliye Musluğu - Purjör - Kollektör Tapası

KOD	AÇIKLAMA	K. AD.	B. FİYATI
18.09.345	1" Purjörlü Kollektör Tapası	450	64,45 TL
18.09.350	Manuel Purjörlü Tahliye Mus.	75	272,00 TL
18.09.351	Otomatik Purjörlü Tahliye Mus.	75	405,00 TL
80.57.608	Bakım Yapılabilir Oto. Purjör	??	214,00 TL
80.57.507	1/2" Otomatik Purjör	76	203,00 TL
80.51.550	Test Nipel	1000	16,85 TL
80.51.570	Test Nipel (Çekvalfli)	1600	41,80 TL

### ► H-Ventil / By - Pass Bağlantı

KOD	AÇIKLAMA	K. AD.	B. FİYATI
14.01.878	16 x 2 Deliksiz	40	317,00 TL
06.05.881	H - Ventil	40	522,00 TL

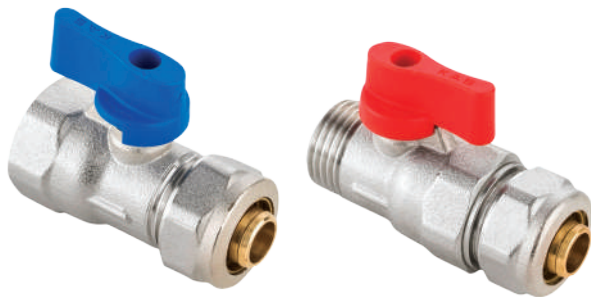

### ► Yerden Isıtma Mini Küresel Vana

KOD	AÇIKLAMA	K. AD.	B. FİYATI
05.01.312	16 x 2 - 1/2" İç Dişli	180	131,50 TL
05.01.313	17 x 2 - 1/2" İç Dişli	150	204,00 TL
05.02.311	16 x 2 - 3/8" Dış Dişli	150	118,70 TL
05.02.312	16 x 2 - 1/2" Dış Dişli	150	158,30 TL
05.02.313	17 x 2 - 1/2" Dış Dişli	100	235,00 TL

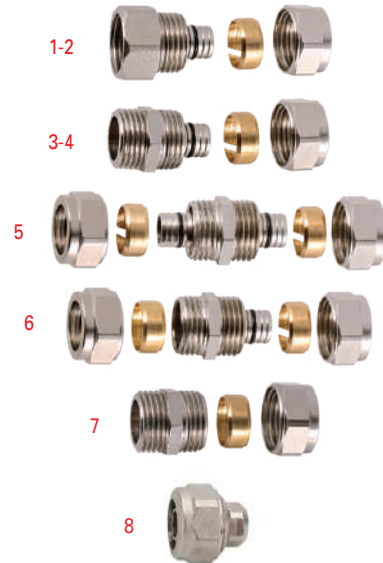

### ► Yerden Isıtma Bağlantı Rakorları

KOD	AÇIKLAMA	K. AD.	B. FİYATI
1	06.02.315 16 x 2 İç Dişli	250	68,78 TL
2	06.02.316 17 x 2 İç Dişli	250	95,61 TL
3	06.01.317 17 x 2 Dış Dişli	250	89,80 TL
4	06.01.318 16 x 2 Dış Dişli	250	58,34 TL
5	06.03.319 16 x 2 Hortum - Hortum	250	96,70 TL
6	06.03.320 16 x 2 Hortum - Boru	250	88,41 TL
7	06.01.314 16 x 2 Boru Bağ. Rakoru Dış Dişli	250	49,68 TL
8	06.04.480 16 x 2 Hortum Kör Tapa	250	44,90 TL

## ► KAS YERDEN ISITMA SİSTEMLERİ



### ► Kollektör Bağlantı Grubu

KOD	AÇIKLAMA	K. AD.	B. FİYATI
70.01.390	40cm Kollektör Dolabı	1	1.279,00 TL
70.01.391	60cm Kollektör Dolabı	1	1.514,00 TL
70.01.392	80cm Kollektör Dolabı	1	2.322,00 TL
70.01.491	60cm Kollektör Dolabı-KasTherm	1	3.455,00 TL
70.01.492	80cm Kollektör Dolabı-KasTherm	1	4.241,00 TL
70.01.493	100cm Kollektör Dolabı-KasTherm	1	5.340,00 TL
70.01.494	120cm Kollektör Dolabı-KasTherm	1	6.282,00 TL
18.20.502	1" Kollektör Kelepçesi	40	56,64 TL
18.20.503	1 1/4" Kollektör Kelepçesi	30	113,60 TL
18.20.504	1" Kollektör Kelepçesi	40	56,26 TL

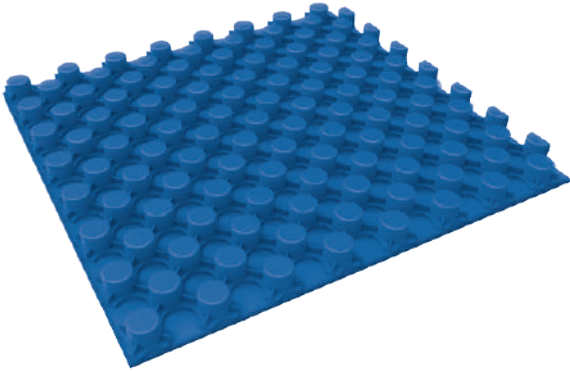

### ► Yerden Isıtma İzolasyon Paneli - Kenar İzolasyon Bandı

KOD	AÇIKLAMA	K. AD.	B. FİYATI
20.08.010	İzolasyon Paneli - Folyolu 72 x 72 cm - 0,51m <sup>2</sup>	10	Fiyat Sorunuz
20.08.011	İzolasyon Paneli 60x120 cm - 0,72m <sup>2</sup>	10	Fiyat Sorunuz
20.08.020	Kenar İzolasyon Bandı 25m	1	499,00 TL



### ► Boru Fittings Sıkma Aparatı

KOD	AÇIKLAMA	K. AD.	B. FİYATI
20.08.001	16-20-25-32 Çene	1	12.379,00 TL



### ► 5 Katmanlı A Plus Pe-Rt Boru

KOD	AÇIKLAMA	METRE	B. FİYATI
80.50.016	16 x 2 - 5 Katmanlı	400	14,35 TL



### ► Şap Katkısı

KOD	AÇIKLAMA	K. AD.	B. FİYATI
20.08.002	-	10 L	2.914,00 TL



### ► KasTherm Sunum Çantası

KOD	AÇIKLAMA	K. AD.	B. FİYATI
20.09.001	Büyük Boy	1	9.304,00 TL
20.09.002	Küçük Boy	1	7.131,00 TL

## ► KAS YERDEN ISITMA SİSTEMLERİ



### ► Radyatör Bağlantı Borusu (Pirinç)

KOD	AÇIKLAMA	K. AD.	B. FİYATI
40.00.040	40 cm	100	132,30 TL
40.00.050	50 cm	100	153,50 TL
40.00.060	60 cm	100	174,60 TL
40.00.090	90 cm	100	279,00 TL



### ► Radyatör Bağlantı Borusu S'li - Rakorlu

KOD	AÇIKLAMA	K. AD.	B. FİYATI
40.04.040	1/2" - 16x2 Pex-B Bağlantı 40 cm	50	158,00 TL
40.04.050	1/2" - 16x2 Pex-B Bağlantı 50 cm	50	161,00 TL
40.04.060	1/2" - 16x2 Pex-B Bağlantı 60 cm	50	163,60 TL
40.04.090	1/2" - 16x2 Pex-B Bağlantı 90 cm	50	233,00 TL



### ► Radyatör Bağlantı Borusu Düz - Rakorlu

KOD	AÇIKLAMA	K. AD.	B. FİYATI
40.02.040	1/2" - 16x2 Pex-B Bağlantı 40 cm	70	154,50 TL
40.02.050	1/2" - 16x2 Pex-B Bağlantı 50 cm	70	159,00 TL
40.02.060	1/2" - 16x2 Pex-B Bağlantı 60 cm	50	164,80 TL
40.02.090	1/2" - 16x2 Pex-B Bağlantı 90 cm	50	217,00 TL



### ► Radyatör Bağlantı Borusu Dirsekli - Rakorlu

KOD	AÇIKLAMA	K. AD.	B. FİYATI
40.10.010	1/2"-16x2 Pex-B Bağlantı 10cm -85°	200	113,50 TL
40.11.010	1/2"-16x2 Pex-B Bağlantı 10cm -90°	200	113,50 TL
40.20.040	1/2"-16x2 Pex-B Bağlantı 40cm	50	160,90 TL
40.20.050	1/2"-16x2 Pex-B Bağlantı 50cm	50	165,80 TL
40.20.060	1/2"-16x2 Pex-B Bağlantı 60cm	50	168,10 TL
40.20.090	1/2"-16x2 Pex-B Bağlantı 90cm	50	225,00 TL

# FLEX GRUBU

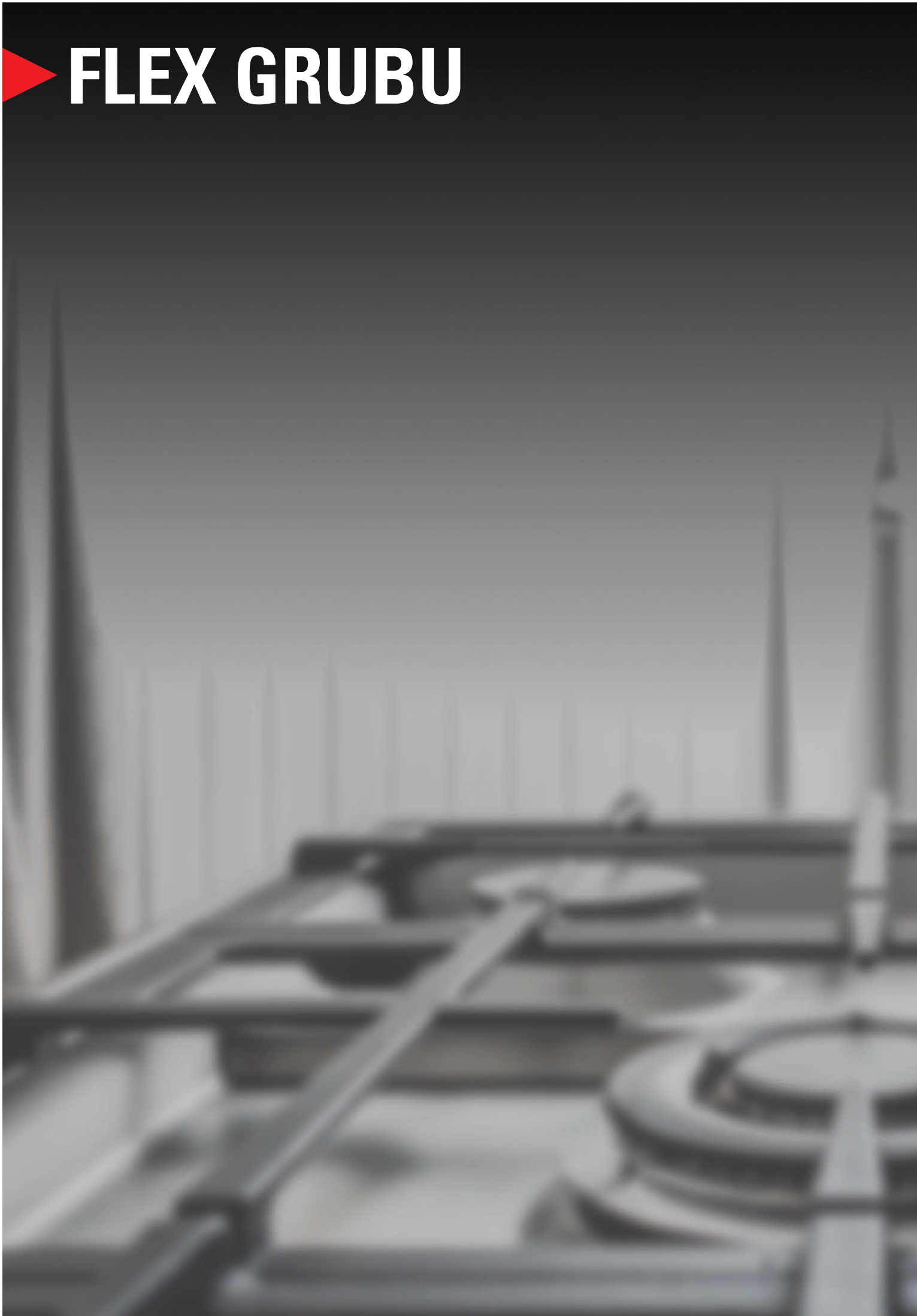



*Paslanmaz elik tel rgs ve kaliteli dıř kaplamasıyla*

# ***Gaz tesisatınızın en gvenilir halkası ocak flexleri 7 tel ve 316L paslanmaz hortum ile artık daha gvenli...***

**TS EN 14800** Avrupa standartlarına gre retilen, ocak, fırın, kombi vb. gaz yakan cihazlarda kullanılan, eęilebilir ve bklebilir yapıya sahip, **gvenilir, abuk ve kolay baęlantı** saęlayan Gaz Baęlantı Flexleri ile zamandan tasarruf saęlayın.



## ► FLEX GRUPLARI



**TS 14800**

► **Ocak Doğalgaz Bağlantı Flexleri - Örgülü (316 L)**

KOD	N	S	DN	U	K. AD.	B. FİYATI
54.09.050	1/2"	1/2"	DN12	50 cm	25	219,00 TL
54.09.075	1/2"	1/2"	DN12	75 cm	25	259,00 TL
54.09.100	1/2"	1/2"	DN12	100 cm	25	278,00 TL
54.09.125	1/2"	1/2"	DN12	125 cm	25	306,00 TL
54.09.150	1/2"	1/2"	DN12	150 cm	20	381,00 TL



**TS 13890**

► **Kombi Doğalgaz Bağlantı Flexleri - Makaronlu (316 L)**

KOD	N	S	DN	U	K. AD.	B. FİYATI
42.80.040	3/4"	3/4"	DN16	40 cm	50	162,90 TL
42.80.050	3/4"	3/4"	DN16	50 cm	50	176,60 TL
42.80.060	3/4"	3/4"	DN16	60 cm	30	186,60 TL
42.80.090	3/4"	3/4"	DN16	90 cm	30	219,00 TL
42.80.120	3/4"	3/4"	DN16	120 cm	30	244,00 TL



**TS 13890**

► **Kompansatör Bağlantı - Makaronlu (316 L)**

KOD	B	B	DN	U	K. AD.	B. FİYATI
Kaynaklı						
48.02.060	1"	1"	DN25	60 cm	25	584,00 TL
48.12.065	1 1/4"	1 1/4"	DN32	65 cm	20	822,00 TL
48.22.075	1 1/2"	1 1/2"	DN40	75 cm	10	1.527,00 TL
48.32.085	2"	2"	DN50	85 cm	8	1.932,00 TL
KOD	N	N	DN	U	K. AD.	B. FİYATI
Dişli						
47.57.060	1"	1"	DN25	60 cm	25	404,00 TL
47.59.065	1 1/4"	1 1/4"	DN32	65 cm	20	1.056,00 TL
47.61.075	1 1/2"	1 1/2"	DN40	75 cm	10	1.503,00 TL
47.63.085	2"	2"	DN50	85 cm	8	2.268,00 TL



**TS 13890**

► **Sayaç Bağlantı Flexi - Makaronlu (316 L)**

KOD	N	S	DN	U	K. AD.	B. FİYATI
50.80.020	1"	1 1/4"	DN25	20 cm	30	341,00 TL
50.80.023	1"	1 1/4"	DN25	23 cm	30	341,00 TL
50.80.025	1"	1 1/4"	DN25	25 cm	25	348,00 TL
50.80.032	1"	1 1/4"	DN25	32 cm	50	355,00 TL
49.41.035	1 1/2"	2"	DN40	35 cm	10	1.253,00 TL
49.51.035	2"	2 1/2"	DN50	35 cm	8	1.485,00 TL

## ► FLEX GRUPLARI

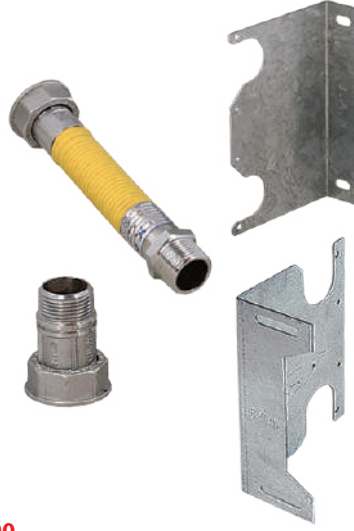

**TS 13890**

### ► Sayaç Bağlantı Flex Seti - Makaronlu (316 L)

KOD	AÇIKLAMA	K. AD.	B. FİYATI
50.92.020-2	1" 20 cm Ön Bağ. DN25 - 13890	20	468,00 TL
50.90.025-2	1" 25 cm Ön Bağ. DN25 - 13890	20	482,00 TL
50.90.032-2	1" 32 cm Ön Bağ. DN25 - 13890	20	493,00 TL
50.91.020-2	1" 20 cm Yan Bağ. DN25 - 13890	20	463,00 TL
50.93.020	1" 20 cm Ön Bağ. DN25 - 13890	20	531,00 TL
50.93.023	1" 23 cm Ön Bağ. DN25 - 13890	20	525,00 TL



### ► Sayaç Bağlantı Elemanları

KOD	AÇIKLAMA	K. AD.	B. FİYATI
46.02.440	7.5 cm Konsol Sacı - Ön Bağlantı	50	35,56 TL
46.02.450	8.5 cm Konsol Sacı - Ön Bağlantı	50	33,14 TL
46.02.452	9.5 cm Konsol Sacı - Ön Bağlantı	50	44,25 TL
46.02.453	10.5 cm Konsol Sacı - Ön Bağlantı	50	36,55 TL
46.02.451	Konsol Sacı - Yan Bağlantı	50	38,70 TL
46.20.460-2	1" Sayaç Rakoru (Döküm)	50	127,80 TL
46.20.461	1" Sayaç Rakoru (Kromlu Döküm)	50	188,10 TL
46.20.463	1" Sayaç Rakoru (Purjörülü)	50	267,00 TL
46.20.470	G 10 - 16 Sayaç Rakoru (Çelik)	50	206,00 TL
46.20.480	G 25 Sayaç Rakoru (Çelik)	25	376,00 TL



## ► FLEX GRUPLARI



TS 13890

### ► Kaskad Gaz Bağlantı Flexi (316 L)

KOD	N	S	DN	U	K. AD.	B. FİYATI
50.70.020	1"	1"	DN25	20 cm	30	214,00 TL
50.70.030	1"	1"	DN25	30 cm	20	230,00 TL
50.70.040	1"	1"	DN25	40 cm	30	254,00 TL
50.70.050	1"	1"	DN25	50 cm	25	276,00 TL
50.70.060	1"	1"	DN25	60 cm	25	297,00 TL



TS 13890

### ► Brülör Bağlantı Flexleri - Makaronlu (316 L)

KOD	N	N	DN	U	K. AD.	B. FİYATI
49.03.017	1"	1"	DN25	17 cm	20	195,40 TL
49.12.019	1 1/4"	1 1/4"	DN32	19 cm	15	639,00 TL
49.22.021	1 1/2"	1 1/2"	DN40	21 cm	10	793,00 TL
49.32.021	2"	2"	DN50	21 cm	8	1.181,00 TL



### ► Fancoil Flexleri - Çıplak

KOD	N	S	DN	U	K. AD.	B. FİYATI
43.17.020	1/2"	1/2"	DN12	20 cm	50	97,85 TL
43.17.030	1/2"	1/2"	DN12	30 cm	50	104,20 TL
43.17.040	1/2"	1/2"	DN12	40 cm	50	110,40 TL
43.17.050	1/2"	1/2"	DN12	50 cm	50	116,20 TL
43.17.060	1/2"	1/2"	DN12	60 cm	50	122,00 TL
43.19.020	3/4"	3/4"	DN16	20 cm	50	143,60 TL
43.19.030	3/4"	3/4"	DN16	30 cm	50	152,20 TL
43.19.040	3/4"	3/4"	DN16	40 cm	50	160,10 TL
43.19.050	3/4"	3/4"	DN16	50 cm	50	166,20 TL
43.19.060	3/4"	3/4"	DN16	60 cm	30	174,50 TL
43.21.020	1/2"	3/4"	DN12	20 cm	50	157,30 TL
43.21.030	1/2"	3/4"	DN12	30 cm	50	159,60 TL
43.21.040	1/2"	3/4"	DN12	40 cm	50	167,30 TL
43.21.050	1/2"	3/4"	DN12	50 cm	50	174,70 TL
43.21.060	1/2"	3/4"	DN12	60 cm	30	136,50 TL
43.23.020	3/4"	1"	DN16	20 cm	30	241,00 TL
43.23.030	3/4"	1"	DN16	30 cm	30	248,00 TL
43.23.040	3/4"	1"	DN16	40 cm	30	258,00 TL
43.23.050	3/4"	1"	DN16	50 cm	30	262,00 TL
43.23.060	3/4"	1"	DN16	60 cm	25	268,00 TL



### ► Fancoil Flexleri - İzoleli

KOD	N	S	DN	U	K. AD.	B. FİYATI
43.18.020	1/2"	1/2"	DN12	20 cm	25	102,80 TL
43.18.030	1/2"	1/2"	DN12	30 cm	25	109,70 TL
43.18.040	1/2"	1/2"	DN12	40 cm	25	118,00 TL
43.18.050	1/2"	1/2"	DN12	50 cm	25	125,30 TL
43.18.060	1/2"	1/2"	DN12	60 cm	25	132,70 TL
43.20.020	3/4"	3/4"	DN16	20 cm	20	146,80 TL
43.20.030	3/4"	3/4"	DN16	30 cm	20	156,80 TL
43.20.040	3/4"	3/4"	DN16	40 cm	20	166,00 TL
43.20.050	3/4"	3/4"	DN16	50 cm	20	175,90 TL
43.20.060	3/4"	3/4"	DN16	60 cm	20	187,00 TL
43.22.020	1/2"	3/4"	DN12	20 cm	25	161,80 TL
43.22.030	1/2"	3/4"	DN12	30 cm	25	166,80 TL
43.22.040	1/2"	3/4"	DN12	40 cm	25	174,60 TL
43.22.050	1/2"	3/4"	DN12	50 cm	25	180,10 TL
43.22.060	1/2"	3/4"	DN12	60 cm	25	183,30 TL
43.24.020	3/4"	1"	DN16	20 cm	25	245,00 TL
43.24.030	3/4"	1"	DN16	30 cm	25	251,00 TL
43.24.040	3/4"	1"	DN16	40 cm	25	263,00 TL
43.24.050	3/4"	1"	DN16	50 cm	25	277,00 TL
43.24.060	3/4"	1"	DN16	60 cm	25	281,00 TL



## ► FLEX GRUPLARI



**TS 10380**

### ► Sprink Fleksi ve Bağlantı Seti

KOD	M	N	DN	U	K. AD.	B. FİYATI
57.20.050	1/2"	1"	DN20	50 cm	8	451,00 TL
57.20.070	1/2"	1"	DN20	70 cm	8	474,00 TL
57.20.100	1/2"	1"	DN20	100 cm	8	512,00 TL



### ► Su Bağlantı Flexleri

KOD	N	S	DN	U	K. AD.	B. FİYATI
44.20.010	1/2"	1/2"	DN12	10 cm	100	104,50 TL
44.20.020	1/2"	1/2"	DN12	20 cm	100	106,70 TL
44.20.030	1/2"	1/2"	DN12	30 cm	75	112,10 TL
44.20.040	1/2"	1/2"	DN12	40 cm	75	118,10 TL
44.20.050	1/2"	1/2"	DN12	50 cm	50	121,50 TL
44.20.060	1/2"	1/2"	DN12	60 cm	50	125,50 TL
44.20.090	1/2"	1/2"	DN12	90 cm	50	140,50 TL

### ► Su Bağlantı Flexleri

KOD	N	S	DN	U	K. AD.	B. FİYATI
44.22.010	1/2"	3/4"	DN12	10 cm	100	156,40 TL
44.22.020	1/2"	3/4"	DN12	20 cm	50	161,90 TL
44.22.030	1/2"	3/4"	DN12	30 cm	50	167,60 TL
44.22.040	1/2"	3/4"	DN12	40 cm	50	172,30 TL
44.22.050	1/2"	3/4"	DN12	50 cm	50	176,20 TL
44.22.060	1/2"	3/4"	DN12	60 cm	50	179,50 TL

KOD	N	S	DN	U	K. AD.	B. FİYATI
45.23.010	3/4"	3/4"	DN16	10 cm	60	126,10 TL
45.23.020	3/4"	3/4"	DN16	20 cm	60	135,10 TL
45.23.030	3/4"	3/4"	DN16	30 cm	50	139,90 TL
45.23.040	3/4"	3/4"	DN16	40 cm	50	148,20 TL
45.23.050	3/4"	3/4"	DN16	50 cm	50	154,50 TL
45.23.060	3/4"	3/4"	DN16	60 cm	30	160,10 TL

## ► FLEX GRUPLARI

### KUTU (REGÜLATÖR) BAĞLANTI FLEXLERİ TS 13890

#### ► Nipel + Nipel Serisi

KOD	AÇIKLAMA	K. AD.	B. FİYATI
47.10.021	1 1/4" 20 cm (Mak. Paslanmaz N.)	25	399,00 TL
47.12.030-2	1 1/4" 30 cm (Mak. Paslanmaz N.)	20	349,00 TL

KOD	AÇIKLAMA	K. AD.	B. FİYATI
47.15.020-2	1 1/4" 11/11 Diş 20 cm Mak. Paslanmaz	25	369,00 TL

KOD	AÇIKLAMA	K. AD.	B. FİYATI
47.23.030	1 1/4" 14/11 Diş 30 cm Mak. Paslanmaz	25	675,00 TL

KOD	AÇIKLAMA	K. AD.	B. FİYATI
47.25.034	2" 11/11 Diş 34 cm Mak. Paslanmaz	8	1.720,00 TL

KOD	AÇIKLAMA	K. AD.	B. FİYATI
47.64.017-2	1 1/4" 11/11 Diş 16,5 cm Mak. Paslanmaz	25	295,00 TL
47.65.025-2	1 1/4" 11/11 Diş 25 cm Mak. Paslanmaz	25	402,00 TL

KOD	AÇIKLAMA	K. AD.	B. FİYATI
47.67.025-2	1 1/4" 11/11 Diş 25 cm Mak. Paslanmaz	25	317,00 TL

#### ► Kısa Nipel + Boru Serisi

KOD	AÇIKLAMA	K. AD.	B. FİYATI
47.43.020	1 1/4" 14 Diş 20 cm Mak. Paslanmaz	25	652,00 TL

KOD	AÇIKLAMA	K. AD.	B. FİYATI
47.45.020-2	1 1/4" 11 Diş 20 cm Mak. Paslanmaz	25	647,00 TL

#### ► Nipel + Rakor Serisi

KOD	AÇIKLAMA	K. AD.	B. FİYATI
47.41.020	1 1/4" 11 Diş 20 cm Mak. Paslanmaz	25	714,00 TL

#### ► Nipel + Boru Serisi

KOD	AÇIKLAMA	K. AD.	B. FİYATI
47.37.020	1 1/4" 11 Diş 20 cm Mak. Paslanmaz	25	584,00 TL



## ► FLEX GRUPLARI

### KUTU (REGÜLATÖR) BAĞLANTI FLEXLERİ TS 13890

#### ► Kısa Nipel + Nipel Serisi

KOD	AÇIKLAMA	K. AD.	B. FİYATI
47.49.017-2	1 1/4" 11/14 Diş 16,5 cm Mak. Paslanmaz	25	365,00 TL
47.49.020-2	1 1/4" 11/14 Diş 20 cm Mak. Paslanmaz	25	396,00 TL

KOD	AÇIKLAMA	K. AD.	B. FİYATI
47.39.025-2	1 1/4" 11 Diş 25 cm Mak. Paslanmaz	20	507,00 TL

#### ► Rakor + Boru Serisi

KOD	AÇIKLAMA	K. AD.	B. FİYATI
47.35.020	1 1/4" 11 Diş 20 cm Mak. Paslanmaz	20	786,00 TL

KOD	AÇIKLAMA	K. AD.	B. FİYATI
47.51.027-2	1 1/4" 11/11 Diş 27 cm Mak. Paslanmaz	20	566,00 TL
47.70.027-2	1 1/4" 11/11 Diş 27 cm Mak. Paslanmaz	20	564,00 TL

#### ► Nipel + Manşon Serisi

KOD	AÇIKLAMA	K. AD.	B. FİYATI
47.21.020-2	1 1/4" 11/11 Diş 20 cm (Mak. Paslanmaz)	25	533,00 TL

KOD	AÇIKLAMA	K. AD.	B. FİYATI
47.27.020	1 1/4" 14/11 Diş 20 cm Mak. Paslanmaz	25	692,00 TL

KOD	AÇIKLAMA	K. AD.	B. FİYATI
47.29.020	2" 11/11 Diş 20 cm Mak. Paslanmaz	8	1.666,00 TL

KOD	AÇIKLAMA	K. AD.	B. FİYATI
47.31.030	2" 11/11 Diş 34 cm Mak. Paslanmaz	8	1.804,00 TL

KOD	AÇIKLAMA	K. AD.	B. FİYATI
47.68.022-2	1 1/4" 11/11 Diş 21,5 cm Mak. Paslanmaz	25	516,00 TL
47.69.022	1 1/2" 11/11 Diş 21,5 cm Mak. Paslanmaz	15	1.110,00 TL
47.04.030	2" 30 cm Kutu Flex Mak. Paslanmaz	8	1.695,00 TL
47.06.030	2" 30 cm Kutu Flex N-N (Mak.)	8	1.658,00 TL

#### ► Kör Tapa

KOD	AÇIKLAMA	K. AD.	B. FİYATI
46.08.007	1 1/4" 14 İnce Diş	100	97,30 TL
46.08.008	1 1/4" 11 Kalın Diş	100	97,30 TL



# ▶ **KASTAK GRUBU**





Köşeyi döndüren tesisat

## **Dirsek yok, kaynak yok, avantajı çok!**

- Tesisat bölgelerinde kirliliği ve zararı **en aza indirir.**
- Kaynak, pafta, kesme taşı, keten ve macun **gerektirmez.**
- Esnekliği sayesinde dirsek kullanımına **ihtiyaç yoktur.**
- Paslanmaz çelik hortumu ve dış kılıfı ile aşınmaya, paslanmaya **dayanıkladır.**
- Kanalların içerisine yerleştirilmesi sayesinde **estetik bir görüntü sağlar.**
- Depreme ve yangına daha dayanıklıdır. Japonya ve A.B.D'de 25 yılı aşkın süredir **güvenle kullanılmaktadır.**



# Kastak Esnek Tesisat Sistemi

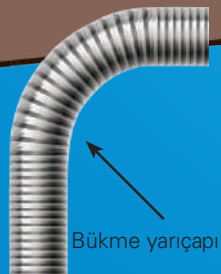
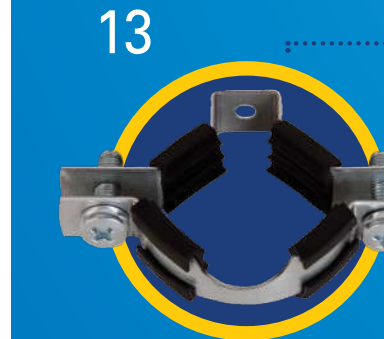

Bükme yarıçapı

## KAS-TAK Hortumu Bükme Yarıçapı

Asgari bükme yarıçapı (mm)		
DN 16	DN 20	DN 25
20	25	30

# KASTAK®

yeni nesil doğalgaz tesisatı



7



2



6



4



5

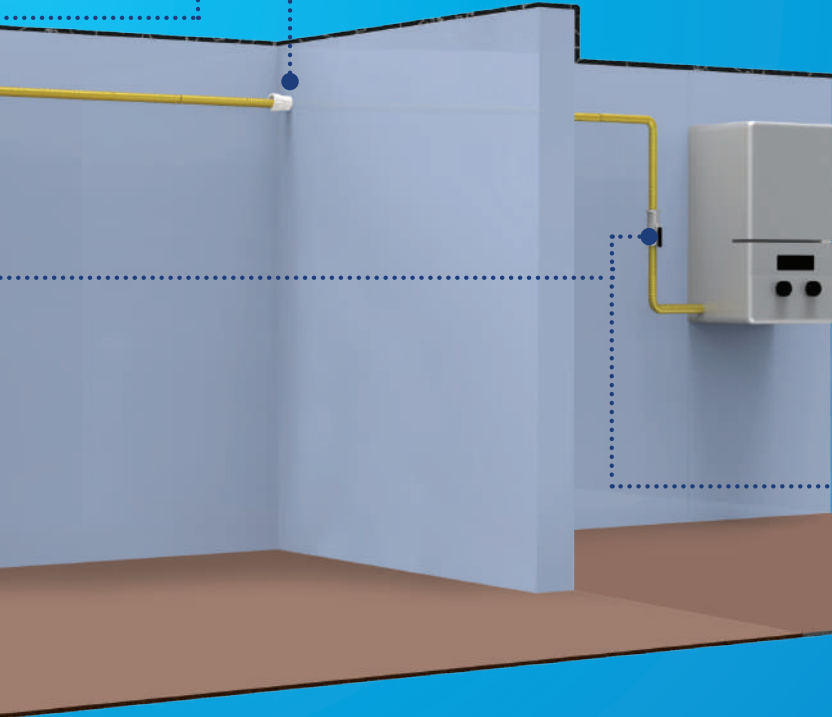

11



12

- 1 L Köşe
- 2 Dış Köşe
- 3 İç Köşe
- 4 Duvar Geçiş Kapağı (Kapalı)
- 5 Duvar Geçiş Kapağı (Açık)
- 6 TE Bağlantı Rakorları
- 7 Hortum Kanalı 3 mt
- 8 Kanal Geçiş Kapağı

- 9 Sayaç Kapama
- 10 Sayaç Bağlantı Rakorları
- 11 Hortum Bağlantı Rakorları
- 12 Rakorlu Doğalgaz Vanası
- 13 Kelepçe
- 14 Açılı Dış Köşe



## ► KASTAK GRUBU



### ► KAS-TAK Daire İçi Tesizat Hortumları

KOD	AÇIKLAMA	K. AD.	B. FİYATI
62.30.016	DN 16 - 45 mt	1	8.388,00 TL
62.30.020	DN 20 - 30 mt	1	5.790,00 TL
62.30.025	DN 25 - 25 mt	1	6.349,00 TL
62.30.050	DN 25 - 50 mt	1	12.783,00 TL
62.33.050	DN 32 - 50 mt	1	16.854,00 TL



### ► Hortum Bağlantı Rakorları

KOD	AÇIKLAMA	K. AD.	B. FİYATI
60.16.012	DN 16 x 1/2"	30	284,00 TL
60.16.016	DN 16 x 3/4"	24	285,00 TL
60.20.012	DN 20 x 1/2"	40	272,00 TL
60.20.016	DN 20 x 3/4"	40	283,00 TL
60.25.012-2	DN 25 x 1/2"	32	297,00 TL
60.25.016-2	DN 25 x 3/4"	32	319,00 TL
60.25.025-2	DN 25 x 1"	32	309,00 TL
60.32.025	DN 32 x 1"	40	829,00 TL
60.32.032	DN 32 x 1 1/4"	32	854,00 TL



### ► Flex Kesme Aparatı

KOD	AÇIKLAMA	K. AD.	B. FİYATI
49.51.001	-	1	Fiyat Sorunuz



### ► T Sıkma Aparatı

KOD	AÇIKLAMA	K. AD.	B. FİYATI
63.01.009	-	1	Fiyat Sorunuz



### ► Rakorlu Doğalgaz Vanası

KOD	AÇIKLAMA	K. AD.	B. FİYATI
66.01.015-2	DN 25 - 1/2"	20	330,00 TL
66.01.020-2	DN 25 - 3/4"	20	371,00 TL



### ► TE Bağlantı Rakorları

KOD	AÇIKLAMA	K. AD.	B. FİYATI
61.20.020-2	DN 25 x DN 20 x DN 20	20	693,00 TL
61.20.021-2	DN 20 x DN 25 x DN 20	10	699,00 TL
61.20.025-2	DN 25 x DN 20 x DN 25	20	689,00 TL
61.25.020-2	DN 25 x DN 25 x DN 20	20	724,00 TL
61.25.025-2	DN 25 x DN 25 x DN 25	20	727,00 TL
61.32.2525-2	DN 32 x DN 25 x DN 25	12	1.407,00 TL
61.32.2532-2	DN 32 x DN 25 x DN 32	12	1.808,00 TL
61.32.3225-2	DN 32 x DN 32 x DN 25	10	1.792,00 TL
61.32.3232	DN 32 x DN 32 x DN 32	10	2.195,00 TL



### ► Flex Çözücü

KOD	AÇIKLAMA	K. AD.	B. FİYATI
60.00.050	-	1	Fiyat Sorunuz



## ► KASTAK GRUBU

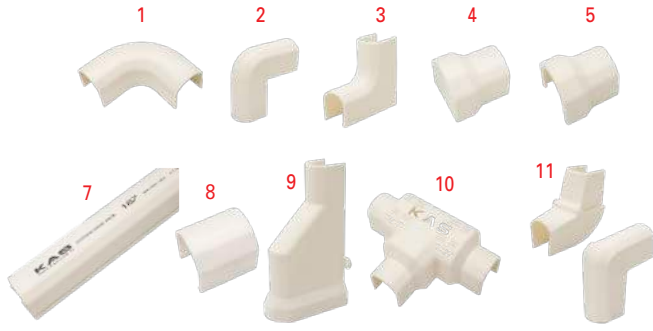

### ► Hortum Kanalları ve Ek Parçaları - DN 25

KOD	AÇIKLAMA	K. AD.	B. FİYATI
KREM			
1	63.21.003	L Köşe	50 39,98 TL
2	63.21.004	Dış Köşe	50 37,04 TL
3	63.21.005	İç Köşe	40 40,29 TL
4	63.21.006	Duvar Geçiş Kapağı (Kapalı)	100 26,25 TL
5	63.21.007	Duvar Geçiş Kapağı (Açık)	100 28,81 TL
7	63.33.002	Hortum Kanalı 2 mt	25 255,00 TL
8	63.21.010	Kanal Geçiş Kapağı	100 22,40 TL
9	63.21.015	Sayaç Kapama	20 54,57 TL
10	63.21.016	TE Kapama	20 48,12 TL
11	63.21.017	Açılı Dış Köşe	50 51,94 TL
	63.21.018	Açılı İç Köşe	50 52,96 TL

#### BEYAZ

1	63.22.003	L Köşe	50 39,98 TL
2	63.22.004	Dış Köşe	50 37,04 TL
3	63.22.005	İç Köşe	40 40,29 TL
4	63.22.006	Duvar Geçiş Kapağı (Kapalı)	100 26,25 TL
5	63.22.007	Duvar Geçiş Kapağı (Açık)	100 28,81 TL
7	63.34.002	Hortum Kanalı 2 mt	25 255,00 TL
8	63.22.010	Kanal Geçiş Kapağı	100 22,40 TL
9	63.22.015	Sayaç Kapama	20 54,57 TL
10	63.22.016	TE Kapama	20 48,12 TL
11	63.22.017	Açılı Dış Köşe	50 51,94 TL
	63.22.018	Açılı İç Köşe	50 52,96 TL

### ► Hortum Kanalları ve Ek Parçaları - DN 32

KOD	AÇIKLAMA	K. AD.	B. FİYATI
63.44.003	L Köşe DN 32	20	75,92 TL
63.44.004	Dış Köşe DN 32	20	77,67 TL
63.44.005	İç Köşe DN 32	20	78,04 TL
63.44.006	Duvar Geçiş Kapağı (Kapalı)	50	67,64 TL
63.44.007	Duvar Geçiş Kapağı (Açık)		66,26 TL
63.44.002	Hortum Kanalı 2 mt DN 32	-	425,00 TL
63.44.010	Kanal Geçiş Kapağı	-	65,52 TL



### ► Sayaç Bağlantı Rakorları (Test Purjölü)

KOD	AÇIKLAMA	K. AD.	B. FİYATI
1	60.20.125	DN 20 - 3/4"	16 703,00 TL
2	60.25.117-2	DN 25 - 1" Dış Dişli Selenoid Bağlantılı	16 422,00 TL
3	60.25.118-2	DN 25 - 1" İç Dişli	16 362,00 TL
4	60.25.125-2	DN 25 - 1 1/4" Döküm Rakorlu	25 641,00 TL
5	60.25.126-2	DN 25 - 1 1/4" Rakorlu	25 535,00 TL
6	60.32.126	DN 32 - 1 1/4" Test Purjölü	20 1.865,00 TL



### ► Bağlantı Kelepçeleri

KOD	AÇIKLAMA	K. AD.	B. FİYATI
1	60.04.011	1/2" Vana Bağlantı	300 36,55 TL
	60.04.012	3/4" Vana Bağlantı	300 30,84 TL
2	60.04.020	DN 20 Te Bağlantı	200 19,32 TL
	60.04.025	DN 25 Te Bağlantı	200 32,60 TL
	60.04.032	DN 32 Te Bağlantı	150 21,33 TL
3	60.05.020	DN 20 Hortum Bağlantı	100 0,00 TL
	60.05.025	DN 25 Hortum Bağlantı	100 0,00 TL
4	60.04.010	DN 25 - 1/2" Vana Bağlantı	100 26,22 TL
	60.04.013	DN 25 - 3/4" Vana Bağlantı	100 0,00 TL

**KAS** | ARMATÜR



KAS | ARMATÜR

# ► Antoryum



## ► Antoryum

► *Renk Seçenekleri için fiyat sorunuz.*

Oro

Rose

Sayfa 71



► **Banyo Armatürü**  
**92.31.951**

K. AD.: 12  
**1.263,00 TL**



► **Lavabo Armatürü**  
**92.31.952**

K. AD.: 12  
**1.254,00 TL**



► **Bide Armatürü**  
**92.31.960**

K. AD.: 12  
**1.306,00 TL**



► **Aplike Evye Armatürü**  
**92.31.957**

K. AD.: 12  
**1.168,00 TL**



► **Duş Armatürü**  
**92.31.958**

K. AD.: 12  
**1.057,00 TL**



## ► Antoryum

► Renk Seçenekleri için fiyat sorunuz.

Oro

Rose

Sayfa 71



### ► Lavabo Armatürü

**92.31.975**

K. AD.: 12

**1.496,00 TL**



### ► Evye Armatürü

**92.31.976**

K. AD.: 12

**1.503,00 TL**



### ► Akrobat Evye Armatürü - Nero

**92.31.977**

K. AD.: 12

**1.725,00 TL**



### ► Akrobat Evye Armatürü - Fumaso

**92.31.978**

K. AD.: 12

**1.725,00 TL**



### ► Akrobat Evye Armatürü - Bianco

**92.31.979**

K. AD.: 12

**1.725,00 TL**

## ► Antoryum

► **Renk Seçenekleri için fiyat sorunuz.**

Oro



Rose



Sayfa 71



### ► **Lavabo Armatürü**

K. AD.: 12

► **U** 92.31.963  
930,00 TL

► **L** 92.31.966  
858,00 TL



### ► **Evye Armatürü**

K. AD.: 12

► **U** 92.31.964  
938,00 TL

► **L** 92.31.967  
872,00 TL

## ► Antoryum Medikal

► *Renk Seçenekleri için fiyat sorunuz.*

Oro

Rose

Sayfa 71



► **Antoryum Döner Lavabo**  
**92.31.968**

K. AD.: 12  
**1.138,00 TL**



► **Antoryum Döner Evye Armatürü**  
**92.31.969**

K. AD.: 12  
**1.145,00 TL**



► **Lavabo Armatürü**  
**92.31.982**

K. AD.: 12  
**1.320,00 TL**



► **Döner Lavabo Armatürü**  
**92.31.980**

K. AD.: 12  
**1.170,00 TL**



► **Döner Evye Armatürü**  
**92.31.981**

K. AD.: 12  
**1.175,00 TL**



## ► Antoryum Bianco



► **Banyo Armatürü**  
**92.31.951-B7**

K. AD.: 12  
**1,473,00 TL**



► **Lavabo Armatürü**  
**92.31.952-B7**

K. AD.: 12  
**1.432,00 TL**



► **Lavabo Armatürü**  
**92.31.963-B7**

K. AD.: 12  
**1.142,00 TL**



► **Evye Armatürü**  
**92.31.964-B7**

K. AD.: 12  
**1.150,00 TL**



## ► Antoryum Nero



► **Banyo Armatürü**  
**92.31.951-B1**

K. AD.: 12  
**1.473,00 TL**



► **Lavabo Armatürü**  
**92.31.952-B1**

K. AD.: 12  
**1.432,00 TL**



► **Lavabo Armatürü**  
**92.31.963-B1**

K. AD.: 12  
**1.142,00 TL**



► **Evye Armatürü**  
**92.31.964-B1**

K. AD.: 12  
**1.150,00 TL**



## ► Antoryum Oro



► **Banyo Armatürü**  
**92.31.951-K1**

K. AD.: 12  
**1.810,00 TL**



► **Lavabo Armatürü**  
**92.31.952-K1**

K. AD.: 12  
**1.805,00 TL**



► **Lavabo Armatürü**  
**92.31.963-K1**

K. AD.: 12  
**1.867,00 TL**



► **Evye Armatürü**  
**92.31.964-K1**

K. AD.: 12  
**1.875,00 TL**

## ► Antoryum Antik



### ► Banyo Armatürü

**92.31.951-K4**

K. AD.: 12

**2.697,00 TL**



### ► Lavabo Armatürü

**92.31.952-K4**

K. AD.: 12

**2.144,00 TL**



### ► Lavabo Armatürü

**92.31.963-K4**

K. AD.: 12

**1.938,00 TL**



### ► Evye Armatürü

**92.31.964-K4**

K. AD.: 12

**1.946,00 TL**



KAS | ARMATÜR

# ► Calista Oro





## ► Calista Oro

► Renk Seçenekleri için fiyat sorunuz.

Oro

Rose

Sayfa 71

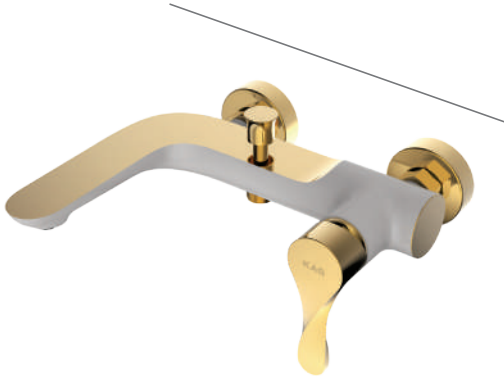

► **Banyo Armatürü**  
**92.41.921**

K. AD.: 10  
**4.272,00 TL**



► **Lavabo Armatürü**  
**92.41.922**

K. AD.: 6  
**3.573,00 TL**



► **Evye Armatürü**  
**92.41.924**

K. AD.: 6  
**5.031,00 TL**



KAS | ARMATÜR

► Calista



## ► Calista

► Renk Seçenekleri için fiyat sorunuz.

Oro

Rose

Sayfa 71



### ► Banyo Armatürü 92.41.821

K. AD.: 10

**3.184,00 TL**



### ► Lavabo Armatürü 92.41.822

K. AD.: 6

**2.713,00 TL**



### ► Evye Armatürü 92.41.824

K. AD.: 6

**4.107,00 TL**



KAS | ARMATÜR

► Lilyum





## ► Lilyum

► Renk Seçenekleri için fiyat sorunuz.

Oro

Rose

Sayfa 71



### ► Banyo Armatürü

**92.43.001**

K. AD.: 12

**2.252,00 TL**



### ► Lavabo Armatürü

**92.43.002**

K. AD.: 12

**1.892,00 TL**



### ► Lüks Evye Armatürü

**92.43.004**

K. AD.: 12

**2.834,00 TL**



### ► Evye Armatürü

**92.43.005**

K. AD.: 12

**1.337,00 TL**



**KAS** | ARMATÜR

▶ **Fione**  
colored



## ► Fione

► Renk Seçenekleri için fiyat sorunuz.

Oro



Rose



Sayfa 71



### ► Banyo Armatürü 92.42.841-B1

K. AD.: 12

**2.233,00 TL**



### ► Lavabo Armatürü

**92.42.842-B7**

K. AD.: 12

**2.106,00 TL**



### ► Lüks Evye Armatürü 92.42.846-B1

K. AD.: 12

**3.245,00 TL**



### ► Evye Armatürü

**92.42.847-B7**

K. AD.: 12

**1.533,00 TL**



**KAS** | ARMATÜR

▶ **Fione**





## ► Fione

► **Renk Seçenekleri için fiyat sorunuz.**

Oro

Rose

Sayfa 71



### ► **Banyo Armatürü**

**92.42.841**

K. AD.: 12

**2.147,00 TL**



### ► **Lavabo Armatürü**

**92.42.842**

K. AD.: 12

**1.869,00 TL**



### ► **Lüks Evye Armatürü**

**92.42.846**

K. AD.: 12

**2.990,00 TL**



### ► **Lavabo Armatürü**

**92.42.849**

K. AD.: 12

**1.361,00 TL**



### ► **Evye Armatürü**

**92.42.847**

K. AD.: 12

**1.416,00 TL**



**KAS** | ARMATÜR

▶ **Arnika**



## ► Arnika

► Renk Seçenekleri için fiyat sorunuz.

Oro

Rose

Sayfa 71



### ► Banyo Armatürü 92.42.101

K. AD.: 12  
1.847,00 TL



### ► Lavabo Armatürü 92.42.102

K. AD.: 12  
1.535,00 TL



### ► Duş Armatürü 92.42.108

K. AD.: 12  
1.279,00 TL



### ► Aplike Evye Armatürü 92.42.107

K. AD.: 12  
1.378,00 TL



## ► Arnika

► **Renk Seçenekleri için fiyat sorunuz.**

Oro



Rose



Sayfa 71



### ► **Lavabo Armatürü**

K. AD.: 12

► **U** 92.42.117  
1.305,00 TL

► **L** 92.42.119  
1.383,00 TL



### ► **Evye Armatürü**

K. AD.: 12

► **U** 92.42.118  
1.337,00 TL

► **L** 92.42.120  
1.401,00 TL



Tüm Armatür Ürünlerimiz  
**320 Farklı Renk**  
**Seçeneđi ile**  
Zevkinize Göre Sizlerle...



KAS | ARMATÜR

# ► Zirkonyum



## ► Zirkonyum



► **Banyo Armatürü**  
**92.31.901**

K. AD.: 12  
**1.323,00 TL**



► **Lavabo Armatürü**  
**92.31.902**

K. AD.: 12  
**1.189,00 TL**



► **Lavabo Armatürü**  
**92.31.903**

K. AD.: 12  
**805,00 TL**



► **Evye Armatürü**  
**92.31.904**

K. AD.: 12  
**830,00 TL**



KAS | ARMATÜR

► Çanak  
5



## ► Çanak

► Renk Seçenekleri için fiyat sorunuz.

Oro

Rose

Sayfa 71



► **Gülnehal Çanak Lavabo**

**92.42.217**

K. AD.: 6

**3.135,00 TL**



► **Gülbade Çanak Lavabo**

**92.41.255**

K. AD.: 6

**5.959,00 TL**



► **Manolya Çanak Lavabo**

**92.41.617**

K. AD.: 6

**3.324,00 TL**



## ► Çanak

► Renk Seçenekleri için fiyat sorunuz.

Oro



Rose



Sayfa 71



► **Antoryum Çanak Lavabo**  
**92.31.971**  
K. AD.: 6  
**3.338,00 TL**



► **Lilyum Çanak Lavabo**  
**92.43.003**  
K. AD.: 6  
**4.108,00 TL**



► **Fione Çanak Lavabo**  
**92.42.843**  
K. AD.: 6  
**4.108,00 TL**



► **Gülistan Çanak Lavabo**  
**92.31.005**  
K. AD.: 6  
**3.898,00 TL**





KAS | ARMATÜR

# ► Evye



## ► Rubini Botti

► Renk Seçenekleri için fiyat sorunuz.

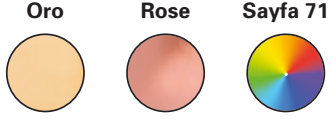

► **Çubuk Kollu Spiralli  
Evye Armatürü**  
**92.52.023**  
K. AD.: 12  
**4.658,00 TL**



► **Çubuk Kollu Spiralli  
Evye Armatürü - Nero**  
**92.52.023-B1**  
K. AD.: 12  
**4.658,00 TL**



► **Şelale Spiralli Evye Armatürü**  
**92.52.026**  
K. AD.: 12  
**4.964,00 TL**



► **Şelale Spiralli  
Evye Armatürü - Nero**  
**92.52.026-B1**  
K. AD.: 12  
**4.964,00 TL**

## ► Rubini Botti

► Renk Seçenekleri için fiyat sorunuz.

Oro

Rose

Sayfa 71



► **Delik Kollu Spiralli  
Evye Armatürü**

**92.52.022**

K. AD.: 12

**4.658,00 TL**



► **Delik Kollu Spiralli  
Evye Armatürü - Oro**

**92.52.022-K1**

K. AD.: 12

**5.373,00 TL**



## ► Evye Armatürleri

► Renk Seçenekleri için fiyat sorunuz.

Oro

Rose

Sayfa 71



► **Adonis U Spiralli Evye Armatürü**  
**92.31.224**  
K. AD.: 12  
**3.226,00 TL**



► **Adonis U-T Spiralli Evye Armatürü**  
**92.31.225**  
K. AD.: 12  
**3.226,00 TL**



► **Viola T Spiralli Evye Armatürü**  
**92.52.033**  
K. AD.: 12  
**3.437,00 TL**



► **Jasmin L Spiralli Evye Armatürü**  
**92.52.014**  
K. AD.: 12  
**3.811,00 TL**

## ► Nero Evye Armatürleri

► Renk Seçenekleri için fiyat sorunuz.

Oro

Rose

Sayfa 71



► **Adonis U Spiralli Evye Armatürü**  
**92.31.224-B1**  
 K. AD.: 12  
**3.500,00 TL**



► **Antik Evye Armatürü**  
**92.43.201**  
 K. AD.: 12  
**4.081,00 TL**



► **Viola T Spiralli Evye Armatürü**  
**92.52.033-B1**  
 K. AD.: 12  
**3.929,00 TL**



► **Jasmin L Spiralli Evye Armatürü**  
**92.52.014-B1**  
 K. AD.: 12  
**3.967,00 TL**





## ► Akrobat Evye Armatürleri

► Renk Seçenekleri için fiyat sorunuz.

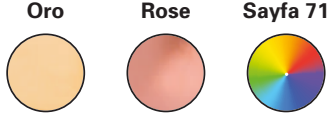

► **Adonis L Akrobat Evye Armatürü**  
**92.31.044**  
K. AD.: 12  
**2.966,00 TL**



► **Adonis U Akrobat Evye Armatürü**  
**92.31.043**  
K. AD.: 12  
**2.946,00 TL**



► **Adonis L Akrobat Evye Armatürü**  
**92.31.044-B1**  
K. AD.: 12  
**3.125,00 TL**



► **Adonis U Akrobat Evye Armatürü**  
**92.31.043-B1**  
K. AD.: 12  
**3.105,00 TL**

## ► Antik Akrobat Evye Armatürleri



► **Antik Akrobat  
Evye Armatürü - Krom**  
**92.43.203**  
K. AD.: 12  
**4.419,00 TL**



► **Antik Akrobat  
Evye Armatürü - Nero**  
**92.43.203-B1**  
K. AD.: 12  
**4.577,00 TL**



► **Antik Akrobat  
Evye Armatürü - Bianco**  
**92.43.203-B7**  
K. AD.: 12  
**4.577,00 TL**



► **Antik Akrobat  
Evye Armatürü - Oro**  
**92.43.203-K1**  
K. AD.: 12  
**5.212,00 TL**



► **Antik Akrobat  
Evye Armatürü - Rose**  
**92.43.203-K2**  
K. AD.: 12  
**5.212,00 TL**





## ► Arıtmalı Nero Evye Armatürleri

► *Renk Seçenekleri için fiyat sorunuz.*

Oro

Rose

Sayfa 71



- **Viole Kare Arıtma Evye Armatürü**  
**92.42.233-B1**  
 K. AD.: 12  
**4.231,00 TL**



- **Lavinya Arıtmalı Evye Armatürü**  
**92.42.232-B1**  
 K. AD.: 12  
**3.397,00 TL**



- **Lavinya 2 in1 Arıtmalı Evye Armatürü**  
**92.42.236-B1**  
 K. AD.: 12  
**2.900,00 TL**



- **Antik 2 in1 Arıtmalı Evye Armatürü**  
**92.43.202-B1**  
 K. AD.: 12  
**4.491,00 TL**



## ► Endüstriyel Evye Armatürleri



► **Çift Çıkışlı Endüstriyel Evye Armatürü**  
**92.52.001**  
K. AD.: 12  
**6.151,00 TL**



► **Tek Çıkışlı Endüstriyel Evye Armatürü**  
**92.52.002**  
K. AD.: 12  
**3.777,00 TL**



**92.52.008**  
K. AD.: 12  
**10.685,00 TL**



**92.52.006**  
K. AD.: 12  
**9.127,00 TL**

► **Profesyonel Çift Çıkışlı Endüstriyel Evye Armatürü**  
**92.52.007**  
K. AD.: 12  
**10.941,00 TL**

► **Profesyonel Tek Çıkışlı Endüstriyel Evye Armatürü**  
**92.52.005**  
K. AD.: 12  
**9.310,00 TL**



# KAS®

*Evimizin her yerindeyiz!*

## Triptonik Sensörlü Su Armatürü



- Ürün içerisinde dereceli dönen kartuş sistemi mevcuttur.
- Ürün mekanik tasarımı sayesinde hem sensör hem de manuel aç-kapa kolu ile elektrik kesintisinde bile kullanıcıya su akışı sağlamaktadır.
- Avrupa üretimi sensör teknolojisi.
- Pili ürünler her ne kadar elektrikli ürünlere göre problemsiz gözükseler bile ortalama 6 ay da bir pil değişimine ihtiyaç duyarlar ve triptonik aç-kapa bataryanın kullanım konforuna ulaşamazlar.



Tasarruf Perlatörü  
**%50'ye varan**  
Su Tasarrufu

Zarif ve İnce Tasarım  
**%100 Piring Ürün**



Elektrik devre dışı kaldığı zamanlarda ise manuel aç-kapa sistemi sayesinde su akışı sağlanabilmektedir.



Elektrik devredeyken ürünler sensör kullanımına olanak sağlamaktadır.



## ► Fotoselli Triptonik

► Renk Seçenekleri için fiyat sorunuz.

Oro

Rose

Sayfa 71



► **Gülnur Fotoselli Triptonik  
Lavabo Armatürü**  
**92.51.065 - Çift Çıkışlı**

K. AD.: 12

**6.070,00 TL**

**92.51.064 - Tek Çıkışlı**

K. AD.: 12

**5.367,00 TL**



► **Lilyum Fotoselli Triptonik  
Lavabo Armatürü**  
**92.51.063 - Çift Çıkışlı**

K. AD.: 12

**5.558,00 TL**

**92.51.062 - Tek Çıkışlı**

K. AD.: 12

**4.747,00 TL**



► **Gülnur Çanak Fotoselli Triptonik  
Lavabo Armatürü**  
**92.51.067 - Çift Çıkışlı**

K. AD.: 12

**7.422,00 TL**

**92.51.066 - Tek Çıkışlı**

K. AD.: 12

**6.719,00 TL**

## ► Fotoselli

► *Renk Seçenekleri için fiyat sorunuz.*

Oro



Rose



Sayfa 71



► **Antoryum Fotoselli  
Lavabo Armatürü**  
**92.51.069 - Çift Çıkışlı - "U"**

K. AD.: 12

**5.248,00 TL**

**92.51.068 - Tek Çıkışlı - "U"**

K. AD.: 12

**4.578,00 TL**



► **Antoryum Fotoselli  
Lavabo Armatürü**  
**92.51.072 - Çift Çıkışlı - "L"**

K. AD.: 12

**6.101,00 TL**

**92.51.071 - Tek Çıkışlı - "L"**

K. AD.: 12

**5.398,00 TL**



► **Gülsude Fotoselli  
Lavabo Armatürü**  
**92.51.074 - Çift Çıkışlı**

K. AD.: 12

**5.749,00 TL**

**92.51.073 - Tek Çıkışlı**

K. AD.: 12

**5.046,00 TL**



## ► Fotoselli

► Renk Seçenekleri için fiyat sorunuz.

Oro



Rose



Sayfa 71



► **Sardunya Fotoselli  
Lavabo Armatürü**  
**92.51.031 - Çift Çıkışlı**

K. AD.: 12

**5.923,00 TL**

**92.51.041 - Tek Çıkışlı**

K. AD.: 12

**5.133,00 TL**



► **Petunya Fotoselli  
Lavabo Armatürü**  
**92.51.011 - Çift Çıkışlı**

K. AD.: 12

**5.953,00 TL**

**92.51.021 - Tek Çıkışlı**

K. AD.: 12

**5.106,00 TL**



► **Fulya Fotoselli  
Lavabo Armatürü**  
**92.51.051 - Çift Çıkışlı**

K. AD.: 12

**5.622,00 TL**

**92.51.061 - Tek Çıkışlı**

K. AD.: 12

**4.832,00 TL**

## ► Musluk



► **Kumru Aç - Kapa  
Kısa Musluk**  
92.11.201  
K. AD.: 50  
589,00 TL



► **Kumru Aç - Kapa  
Uzun Musluk**  
92.11.202  
K. AD.: 50  
589,00 TL



► **Kumru Aç - Kapa  
Çamaşır Musluk**  
92.11.203  
K. AD.: 30  
589,00 TL



► **Antoryum Aç - Kapa  
Kısa Musluk**  
92.11.081  
K. AD.: 50  
392,00 TL



► **Antoryum Aç - Kapa  
Uzun Musluk**  
92.11.082  
K. AD.: 50  
392,00 TL



► **Antoryum Aç - Kapa  
Çamaşır Musluk**  
92.11.083  
K. AD.: 30  
392,00 TL



► **Antoryum Aç - Kapa  
Kısa Musluk**  
92.11.081 - B1  
K. AD.: 50  
539,00 TL



► **Antoryum Aç - Kapa  
Uzun Musluk**  
92.11.082 - B1  
K. AD.: 50  
539,00 TL



► **Antoryum Aç - Kapa  
Çamaşır Musluk**  
92.11.083 - B1  
K. AD.: 30  
539,00 TL

## ► Musluk



► **Çisil Kısa Musluk**  
**92.11.031**

K. AD.: 50  
**355,00 TL**



► **Çisil Uzun Musluk**  
**92.11.032**

K. AD.: 50  
**359,00 TL**



► **Çisil Çamaşır Musluk**  
**92.11.033**

K. AD.: 50  
**355,00 TL**



► **Çisil Kısa Musluk**  
**92.11.031**

K. AD.: 50  
**499,00 TL**



► **Çisil Uzun Musluk**  
**92.11.032**

K. AD.: 50  
**502,00 TL**



► **Çisil Çamaşır Musluk**  
**92.11.033**

K. AD.: 50  
**499,00 TL**



► **Pınar Kısa Musluk**  
**92.11.041**

K. AD.: 50  
**348,00 TL**



► **Pınar Uzun Musluk**  
**92.11.042**

K. AD.: 50  
**350,00 TL**



► **Pınar Çamaşır Musluk**  
**92.11.043**

K. AD.: 50  
**347,00 TL**



## ► Musluk

► Renk Seçenekleri için fiyat sorunuz.

Oro

Rose

Sayfa 71



► **Derya Kısa Musluk**  
**92.11.051**  
K. AD.: 50  
**350,00 TL**



► **Derya Uzun Musluk**  
**92.11.052**  
K. AD.: 50  
**353,00 TL**



► **Derya Çamaşır Musluk**  
**92.11.053**  
K. AD.: 50  
**350,00 TL**



► **Damla Kısa Musluk**  
**92.11.061**  
K. AD.: 50  
**350,00 TL**



► **Damla Uzun Musluk**  
**92.11.062**  
K. AD.: 50  
**353,00 TL**



► **Damla Çamaşır Musluk**  
**92.11.063**  
K. AD.: 50  
**350,00 TL**

## ► Taharet Musluğu (Aç-Kapa)



► **Deniz**  
92.11.365 3/8"  
K. AD.: 50  
258,00 TL



► **Nehir**  
92.11.366 3/8"  
K. AD.: 50  
258,00 TL



► **Irmak**  
92.11.367 3/8"  
K. AD.: 50  
258,00 TL



► **Billur**  
92.11.369 3/8"  
K. AD.: 50  
186,00 TL



► **Yağmur**  
92.11.332 3/8"  
K. AD.: 50  
509,00 TL



► **Yaprak**  
92.11.347 3/8"  
K. AD.: 50  
310,00 TL



► **Sude (Plastik Volan)**  
92.11.373 3/8"  
K. AD.: 50  
177,00 TL



► **Papatya (Kromlu Plastik Volan)**  
92.11.375 3/8"  
K. AD.: 50  
193,00 TL

## ► Taharet Musluğu (Aç-Kapa)

► **Renk Seçenekleri için fiyat sorunuz.**

Oro

Rose

Sayfa 71



► **Pınar**  
92.11.370 3/8"  
K. AD.: 50  
248,00 TL



► **Pınar**  
92.11.370 - B1 3/8"  
K. AD.: 50  
400,00 TL



► **Damla**  
92.11.368 3/8"  
K. AD.: 50  
237,00 TL



► **Damla**  
92.11.368 - B1 3/8"  
K. AD.: 50  
381,00 TL



► **Çisil**  
92.11.374 3/8"  
K. AD.: 50  
251,00 TL



► **Çisil**  
92.11.374 - B1 3/8"  
K. AD.: 50  
400,00 TL



► **Derya**  
92.11.371 3/8"  
K. AD.: 50  
254,00 TL



► **Derya**  
92.11.371 - B1 3/8"  
K. AD.: 50  
402,00 TL



**KAS** | ARMATÜR

▶ **Ankastre**

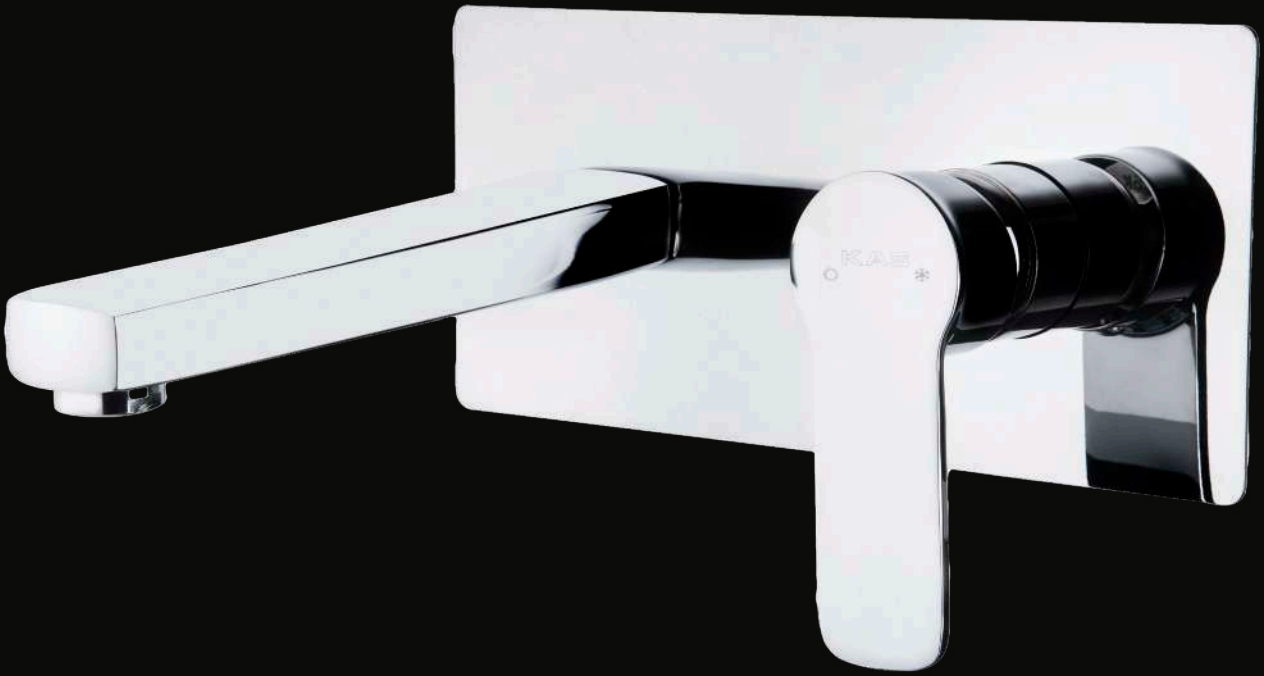

## ► Ankastr Armatür - Duş Seti



### ► Kare Ankastr Duş Seti - Nero

**92.82.152**  
K. AD.: 8  
**6.541,00 TL**



### ► Kare Ankastr Duş Seti - Oro

**92.82.153**  
K. AD.: 8  
**6.541,00 TL**



### ► Elite Ankastr Duş Seti - Nero

**92.82.162**  
K. AD.: 8  
**6.832,00 TL**



### ► Elite Ankastr Duş Seti - Oro

**92.82.161**  
K. AD.: 8  
**6.832,00 TL**



## ► Ankastre Armatür - Duş Seti

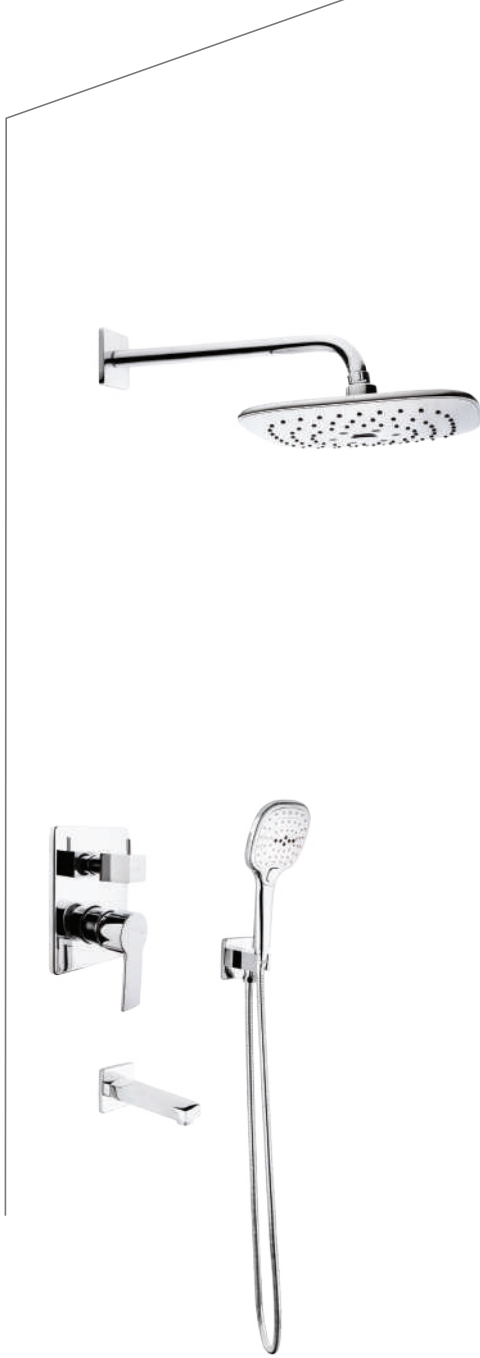

► **Fione**  
**3 Çıkışlı Duvardan**  
**Ankastre Duş Seti**  
**92.82.823**

K. AD.: 8  
**5.409,00 TL**



► **Arnika**  
**3 Çıkışlı Duvardan**  
**Ankastre Duş Seti**  
**92.82.103**

K. AD.: 8  
**5.481,00 TL**



## ► Ankastrre Armatür - Duş Seti



► **Fione**  
3 Çıkışlı Gagadan  
Ankastrre Duş Seti  
92.82.822

K. AD.: 8  
5.051,00 TL



► **Arnika**  
3 Çıkışlı Gagadan  
Ankastrre Duş Seti  
92.82.102

K. AD.: 8  
4.896,00 TL

## ► Ankastrre Armatür - Duş Seti



► **Fione 2 Çıkışlı  
Ankastrre Duş Seti**  
**92.82.821**

K. AD.: 8  
**4.767,00 TL**

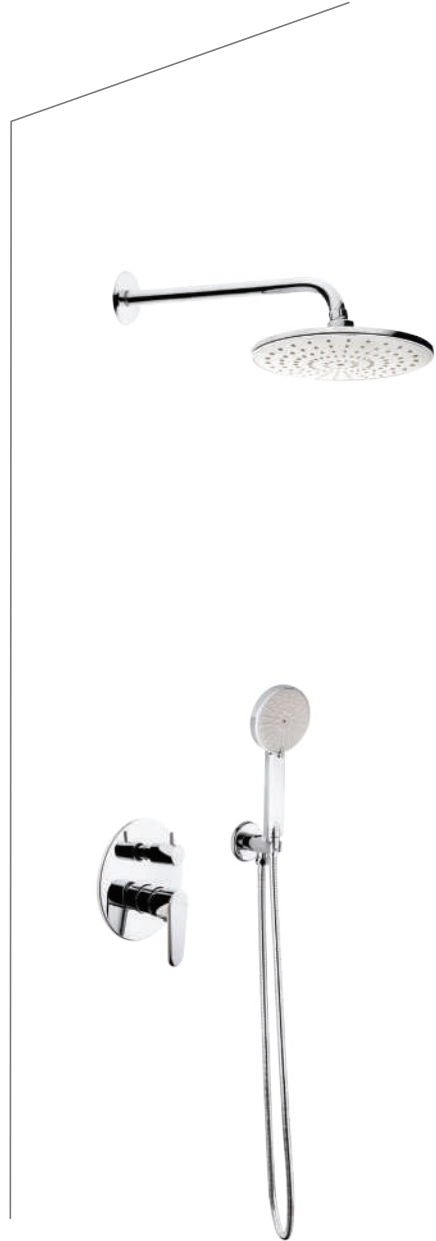

► **Arnika 2 Çıkışlı  
Ankastrre Duş Seti**  
**92.82.101**

K. AD.: 8  
**4.692,00 TL**

## ► Ankastrre Armatür - Duş Seti

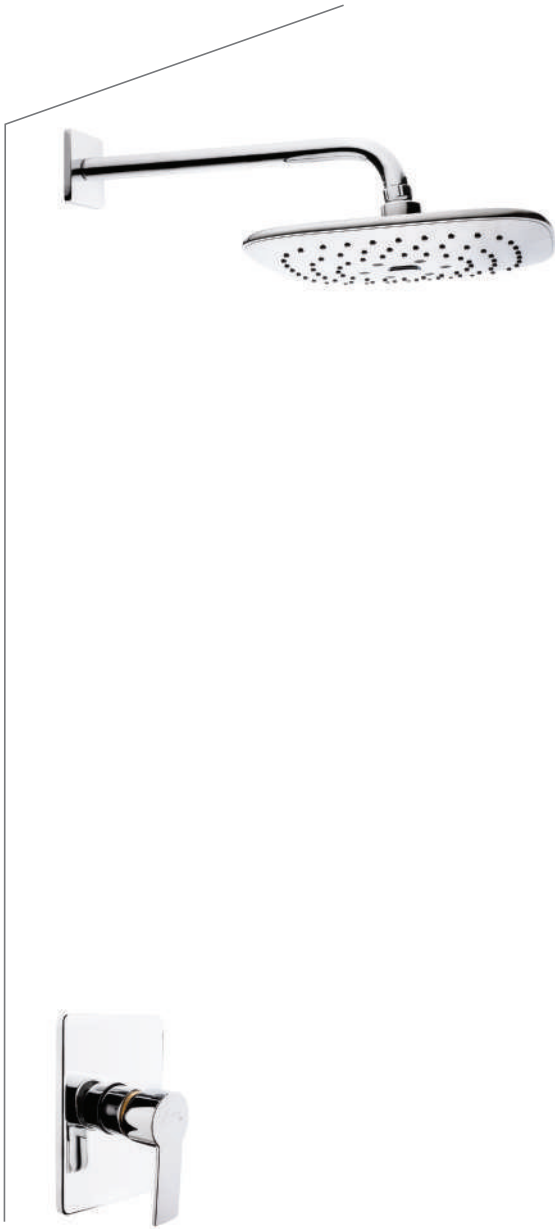

### ► *Fione Tek Çıkışlı Ankastrre Duş Seti*

**92.82.800**

K. AD.: 8

**3.258,00 TL**

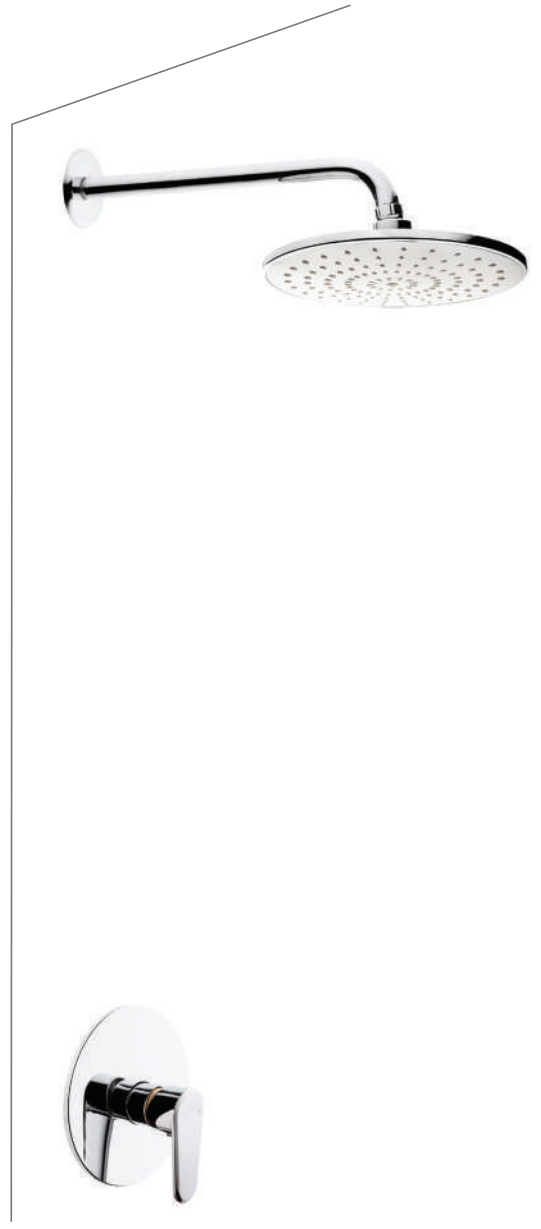

### ► *Arnika Tek Çıkışlı Ankastrre Duş Seti*

**92.82.100**

K. AD.: 8

**3.042,00 TL**



## ► Ankastrre Lavabo

► *Renk Seçenekleri için fiyat sorunuz.*

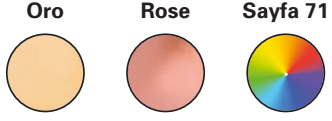

► *Fione Ankastrre Lavabo Armatürü - Nero*

**92.82.830 - B1**

K. AD.: 50

**3.206,00 TL**



► *Fione Ankastrre Lavabo Armatürü - Bianco*

**92.82.830 - B7**

K. AD.: 50

**3.206,00 TL**



► *Fione Ankastrre Lavabo Armatürü - Oro*

**92.82.830 - K1**

K. AD.: 50

**3.692,00 TL**



► *Fione Ankastrre Lavabo Armatürü*

**92.82.830**

K. AD.: 50

**3.053,00 TL**



**\*Tüm ankastrre setlerimizde özel alışımlı (ms60) bakır kullanılmıştır.**

## ► Ankastre



### ► Aç-Kapa Ankastre

**92.11.434 1/2"**

K. AD.: 50  
**324,00 TL**

**92.11.435 3/4"**

K. AD.: 50  
**324,00 TL**



### ► Aç-Kapa Ankastre

**92.11.432 1/2"**

K. AD.: 50  
**324,00 TL**

**92.11.433 3/4"**

K. AD.: 50  
**324,00 TL**



### ► Aç-Kapa Ankastre

**92.11.430 1/2"**

K. AD.: 50  
**295,00 TL**

**92.11.431 3/4"**

K. AD.: 50  
**295,00 TL**



### ► Aç-Kapa Ankastre (Metal Volan)

**92.11.436 1/2"**

K. AD.: 50  
**368,00 TL**

**92.11.437 3/4"**

K. AD.: 50  
**368,00 TL**



### ► Pisuvar Musluğu

**92.81.004**

K. AD.: 12  
**1.577,00 TL**



**KAS** | ARMATÜR

# DUŞ SETLERİ





## ► Panel Duş Seti

► *Renk Seçenekleri için fiyat sorunuz.*

Oro

Rose

Sayfa 71



► *Inci*

**91.30.510**

K. AD.: 1

**12.523,00 TL**



## ► Tepe Duş Setleri



► **Safir**  
**91.31.410**  
K. AD.: 4  
**1.914,00 TL**



► **Kuartz**  
**91.31.010**  
K. AD.: 4  
**1.549,00 TL**

## ► Tepe Duş Setleri



► **Elmas**  
**91.31.310**  
 K. AD.: 4  
**1.567,00 TL**



► **Yakut**  
**91.31.210**  
 K. AD.: 4  
**1.464,00 TL**



## ► Sürgülü Duş Setleri



► **Safir**  
**91.31.420**  
K. AD.: 12  
**670,00 TL**



► **Kuartz**  
**91.31.020**  
K. AD.: 12  
**664,00 TL**



► **Elmas**  
**91.31.320**  
K. AD.: 12  
**534,00 TL**

## ► Sürgülü Duş Setleri



► **Yakut**  
**91.31.220**  
 K. AD.: 12  
**508,00 TL**



► **Zümrüt**  
**91.31.120**  
 K. AD.: 12  
**490 ,00 TL**

## ► Mafsallı Duş Setleri



► **Safir**  
**91.31.430**  
K. AD.: 28  
**447,00 TL**



► **Kuartz**  
**91.31.030**  
K. AD.: 28  
**435,00 TL**



► **Elmas**  
**91.31.330**  
K. AD.: 28  
**276,00 TL**



► **Yakut**  
**91.31.230**  
K. AD.: 28  
**252,00 TL**



► **Zümrüt**  
**91.31.130**  
K. AD.: 28  
**230,00 TL**



## ► Ankastra Duş Başığı



### ► Ankastra Duş Başığı Çok Fonksiyonlu

**91.10.812**

K. AD.: 12

**341,00 TL**



### ► Ankastra Duş Başığı

**91.10.811**

K. AD.: 18

**328,00 TL**



### ► Zümrüt Duş Seti

**91.31.131**

K. AD.: 28

**257,00 TL**



### ► Azurit Duş Seti

**91.31.531**

K. AD.: 28

**463,00 TL**



### ► Lagos Duş Seti

**91.31.631**

K. AD.: 28

**243,00 TL**



### ► Kuartz Duş Seti

**91.31.031**

K. AD.: 28

**456,00 TL**



## ► Yedek Parça

► *Renk Seçenekleri için fiyat sorunuz.*

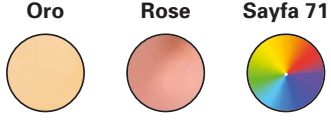

► **Pınar Volan**  
**91.10.134**  
K. AD.: 50  
**110,30 TL**



► **Pınar Volan ve Salmastra**  
**91.10.346**  
K. AD.: 50  
**156,40 TL**



► **Derya Volan**  
**91.10.133**  
K. AD.: 50  
**113,30 TL**



► **Derya Volan ve Salmastra**  
**91.10.348**  
K. AD.: 50  
**156,40 TL**



► **Çișil Volan**  
**91.10.131**  
K. AD.: 50  
**124,00 TL**



► **Çișil Volan ve Salmastra**  
**91.10.345**  
K. AD.: 50  
**172,00 TL**



► **Damla Volan**  
**91.10.132**  
K. AD.: 50  
**118,00 TL**



► **Damla Volan ve Salmastra**  
**91.10.347**  
K. AD.: 50  
**166,00 TL**

## ► Yedek Parça



- **Taharet Salmastrası**  
**92.10.013**  
 K. AD.: 50  
**84,80 TL**



- **35'lik Kısa Kartuş**  
**91.10.232**  
 K. AD.: 50  
**82,70 TL**



- **Aç - Kapa Salmastra**  
**91.10.012**  
 K. AD.: 50  
**155,00 TL**



- **35'lik Ayaklı Kartuş**  
**91.10.231**  
 K. AD.: 50  
**92,00 TL**



- **Salmastra**  
**91.10.011**  
 K. AD.: 50  
**93,30 TL**



- **40'lik Kısa Kartuş**  
**91.10.233**  
 K. AD.: 50  
**85,70 TL**



- **40'lik Ayaklı Kartuş**  
**91.10.234**  
 K. AD.: 50  
**86,30 TL**



- **Kromlu Spiral Hortum - 011**  
**1/2" - 1/2" 150 - 180 cm**  
**91.20.202**  
**204,00 TL**



- **Mat Spiral Hortum - 09**  
**1/2" - 1/2" 150 cm**  
**91.20.200**  
**117,00 TL**



## ► Yedek Parça



► **Lavabo**  
**Armatür Borusu "L"**  
**91.10.071**

K. AD.: 50  
**117,63 TL**



► **Lavabo**  
**Armatür Borusu "U"**  
**91.10.073**

K. AD.: 50  
**117,63 TL**



► **Lavabo**  
**Armatür Borusu "R"**  
**91.10.075**

K. AD.: 50  
**115,54 TL**



► **Evye**  
**Armatür Borusu "L"**  
**91.10.072**

K. AD.: 50  
**151,20 TL**



► **Evye**  
**Armatür Borusu "U"**  
**91.10.074**

K. AD.: 50  
**132,02 TL**



► **Evye**  
**Armatür Borusu "R"**  
**91.10.076**

K. AD.: 50  
**122,44 TL**



► **Bağlantı Hortumu**  
**91.10.021**

K. AD.: 50  
**79,81 TL**



► **Tek Delikli**  
**Bağlantı Parçaları**  
**91.10.035**

K. AD.: 50  
**38,84 TL**



► **Çift Delikli**  
**Bağlantı Parçaları**  
**91.10.037**

K. AD.: 50  
**45,46 TL**



# ONLINE MÜŞTERİ HİZMETLERİ

[www.kas.com.tr](http://www.kas.com.tr)

*Online ileti, anlık takip, kolay kullanım, hızlı sonuç.*



**KAS**



*KAYALAR PRES, AEO sertifikasına sahip bir firmadır.*

**KASPA DIŐ TİC. A.Ő.**

Necip Fazıl Mah. Sađdıç Sok. No: 4 Ümraniye / İSTANBUL - TURKEY  
Tel: +90 216 527 1 527 Faks: +90 216 499 74 76 info@kas.com.tr



**/ kas grup**  
**www.kas.com.tr**